



# 深圳市宇华微科技有限公司

## PRODUCT SPECIFICATION

Doc. Number:

- Tentative Specification
- Preliminary Specification
- Approval Specification

### MODEL NO.: YH070RMD4001

### SUFFIX: R01

<b>Customer:</b>	
<b>APPROVED BY</b>	<b>SIGNATURE</b>
<b>Name / Title</b> _____	
Note : _____	
Please return 1 copy for your confirmation with your signature and comments .	

Approved By	Checked By	Prepared By
		<b>MW Chen</b>



# Contents

1. General Specifications .....	1
2. Pin Assignment .....	2
3. Operation Specifications .....	5
3.1. Absolute Maximum Ratings .....	5
3.1.1. Typical Operation Conditions .....	6
3.1.2. Current Consumption .....	7
3.1.3. Backlight Driving Conditions .....	7
3.2. Power Sequence .....	8
3.3. Timing Characteristics .....	9
3.3.1. AC Electrical Characteristics .....	9
3.3.2. Input Clock and Data Timing Diagram .....	9
3.3.3. Timing .....	10
3.3.4. Data Input Format .....	11
4. Optical Specifications .....	12
5. Reliability Test Items .....	16
6. General Precautions .....	17
6.1. Safety .....	17
6.2. Handling .....	17
6.3. Static Electricity .....	17
6.4. Storage .....	17
6.5. Cleaning .....	17
7. Mechanical Drawing .....	18
8. Package Drawing .....	19
8.1. Packaging Material Table .....	19
8.2. Packaging Quantity .....	19
8.3. Packaging Drawing .....	20

# 1. General Specifications

No.	Item	Specification	Remark
1	LCD size	7.0 inch(Diagonal)	
2	Driver element	a-Si TFT active matrix	
3	Resolution	800 × 3(RGB) × 480	
4	Display mode	Normally White, Transmissive	
5	Dot pitch	0.0642(W) × 0.1790(H) mm	
6	Active area	154.08(W) × 85.92(H) mm	
7	Module size	164.9(W) × 100.0(H) × 4.55(D) mm	Note 1
8	Surface treatment	Anti-Glare	
9	Color arrangement	RGB-stripe	
10	Interface	Digital	
11	Backlight power consumption	TBD	
12	Panel power consumption	0.226W (Typ.)	
13	Weight		

Note 1: Refer to Mechanical Drawing.

## 2. Pin Assignment

1	<b>GLED</b>	<b>GND for LED</b>
2	<b>VLED</b>	<b>Power for LED</b>
3	<b>GND</b>	<b>Ground</b>
4	<b>VDD</b>	<b>Digital power supply(+3.3V)</b>
5	<b>R0</b>	<b>Red data(LSB)</b>
6	<b>R1</b>	<b>Red data</b>
7	<b>R2</b>	<b>Red data</b>
8	<b>R3</b>	<b>Red data</b>
9	<b>R4</b>	<b>Red data</b>
10	<b>R5</b>	<b>Red data</b>
11	<b>R6</b>	<b>Red data</b>
12	<b>R7</b>	<b>Red data(MSB)</b>
13	<b>G0</b>	<b>Green data(LSB)</b>
14	<b>G1</b>	<b>Green data</b>
15	<b>G2</b>	<b>Green data</b>
16	<b>G3</b>	<b>Green data</b>
17	<b>G4</b>	<b>Green data</b>
18	<b>G5</b>	<b>Green data</b>
19	<b>G6</b>	<b>Green data</b>
20	<b>G7</b>	<b>Green data(MSB)</b>
21	<b>B0</b>	<b>Blue data(LSB)</b>
22	<b>B1</b>	<b>Blue data</b>
23	<b>B2</b>	<b>Blue data</b>
24	<b>B3</b>	<b>Blue data</b>
25	<b>B4</b>	<b>Blue data</b>
26	<b>B5</b>	<b>Blue data</b>
27	<b>B6</b>	<b>Blue data</b>
28	<b>B7</b>	<b>Blue data(MSB)</b>
29	<b>GND</b>	<b>Ground</b>
30	<b>DCLK</b>	<b>Data clk</b>
31	<b>DISP</b>	<b>Display ON/OFF control. Internally pulled high</b>
32	<b>HS</b>	<b>Horizontal sync input in RGB mode</b>
33	<b>VS</b>	<b>Vertical sync input in RGB mode</b>
34	<b>DE</b>	<b>Data Enable</b>
35	<b>NC</b>	<b>No connection</b>
36	<b>GND</b>	<b>Ground</b>
37	<b>XR</b>	<b>T/p X-Right(No connection)</b>
38	<b>YD</b>	<b>T/p Y-Bottom(No connection)</b>
39	<b>XL</b>	<b>T/p X-Left(No connection)</b>
40	<b>YU</b>	<b>T/p Y-Up(No connection)</b>

Note 4: Selection of scanning mode

Setting of scan control input		Scanning direction
U/D	L/R	
GND	DV <sub>DD</sub>	Up to down, left to right
DV <sub>DD</sub>	GND	Down to up, right to left
GND	GND	Up to down, right to left
DV <sub>DD</sub>	DV <sub>DD</sub>	Down to up, left to right

Note 5: Definition of scanning direction.  
Refer to the figure as below:

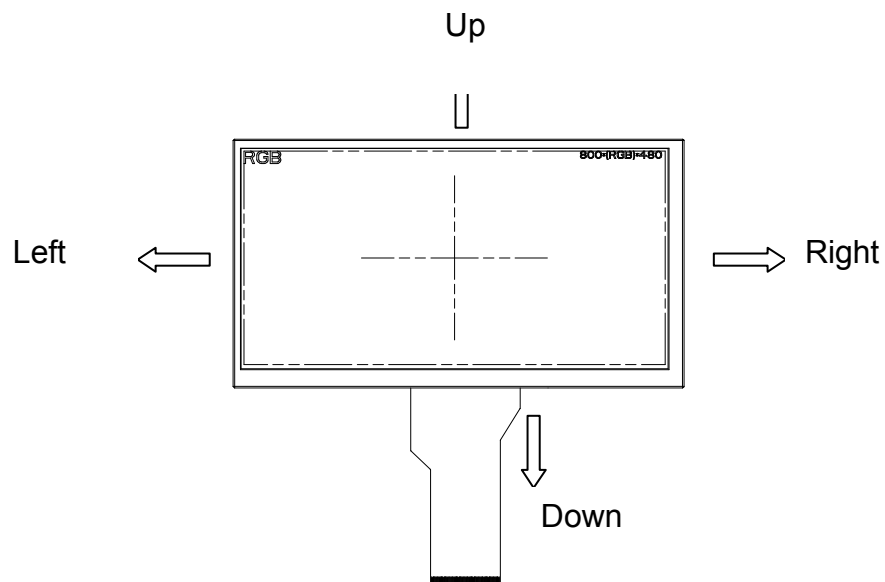

Note 6: Global reset pin. Active low to enter reset state. Suggest to connect with an RC reset circuit for stability. Normally pull high.

Note 7: Dithering function enable control, normally pull high.  
When DITHB="1", Disable internal dithering function,  
When DITHB="0", Enable internal dithering function,

## 3. Operation Specifications

### 3.1. Absolute Maximum Ratings

(Note 1)

Item	Symbol	Values		Unit	Remark
		Min.	Max.		
Power voltage	$DV_{DD}$	-0.3	5.0	V	
	$AV_{DD}$	6.5	13.5	V	
	$V_{GH}$	-0.3	40.0	V	
	$V_{GL}$	-20.0	0.3	V	
	$V_{GH}-V_{GL}$	-	40.0	V	
Operation Temperature	$T_{OP}$	-20	75	°C	
Storage Temperature	$T_{ST}$	-30	80	°C	
LED Reverse Voltage	$V_R$	-	1.2	V	Each LED Note 2
LED Forward Current	$I_F$	-	25	mA	Each LED

Note 1: The absolute maximum rating values of this product are not allowed to be exceeded at any times. Should a module be used with any of the absolute maximum ratings exceeded, the characteristics of the module may not be recovered, or in an extreme case, the module may be permanently destroyed.

Note 2:  $V_R$  Conditions: Zener Diode 20mA

### 3.1.1. Typical Operation Conditions

( Note 1)

Item	Symbol	Values			Unit	Remark
		Min.	Typ.	Max.		
Power voltage	$DV_{DD}$	3.0	3.3	3.6	V	Note 2
	$AV_{DD}$	10.2	10.4	10.6	V	
	$V_{GH}$	15.3	16.0	16.7	V	
	$V_{GL}$	-7.7	-7.0	-6.3	V	
Input signal voltage	$V_{COM}$	3.6	3.8	4.0	V	
Input logic high voltage	$V_{IH}$	$0.7 DV_{DD}$	-	$DV_{DD}$	V	Note 3
Input logic low voltage	$V_{IL}$	0	-	$0.3 DV_{DD}$	V	

Note 1: Be sure to apply  $DV_{DD}$  and  $V_{GL}$  to the LCD first, and then apply  $V_{GH}$ .

Note 2:  $DV_{DD}$  setting should match the signals output voltage (refer to Note 3) of customer's system board.

Note 3: DCLK,HS,VS,RESET,U/D, L/R,DE,R0~R7,G0~G7,B0~B7,MODE,DITHB.

### 3.1.2. Current Consumption

Item	Symbol	Values			Unit	Remark
		Min.	Typ.	Max.		
Current for Driver	$I_{GH}$	-	0.2	1.0	mA	$V_{GH} = 16.0V$
	$I_{GL}$	-	0.2	1.0	mA	$V_{GL} = -7.0V$
	$IDV_{DD}$	-	4.0	10	mA	$DV_{DD} = 3.3V$
	$I_{AV_{DD}}$	-	20	50	mA	$AV_{DD} = 10.4V$

### 3.1.3. Backlight Driving Conditions

Item	Symbol	Values			Unit	Remark
		Min.	Typ.	Max.		
Voltage for LED backlight	$V_L$	8.4	9.3	10.2	V	Note 1
Current for LED backlight	$I_L$	150	180	200	mA	
LED life time	-	20,000	-	-	Hr	Note 2

Note 1: The LED Supply Voltage is defined by the number of LED at  $T_a=25^{\circ}C$  and  $I_L = 180mA$ .

Note 2: The "LED life time" is defined as the module brightness decrease to 50% original brightness at  $T_a=25^{\circ}C$  and  $I_L = 180mA$ . The LED lifetime could be decreased if operating  $I_L$  is larger than 180mA.

### 3.2. Power Sequence

#### Power on sequence

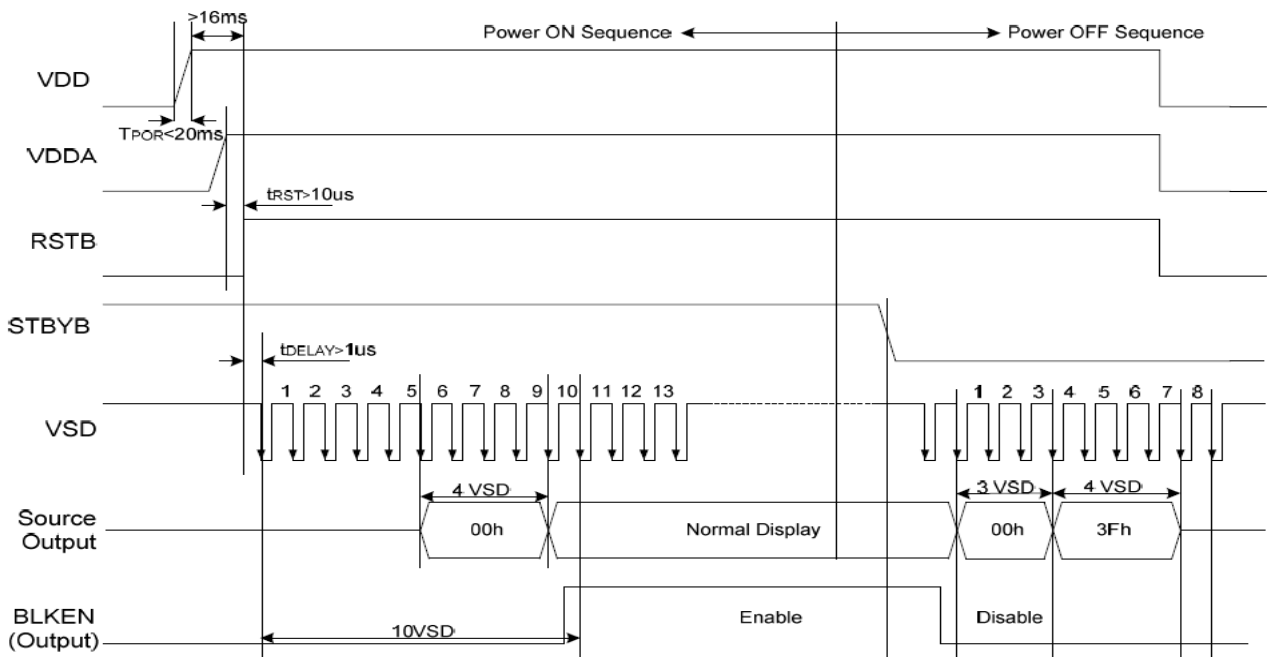

Note: For prevent anormal operation,  $t_{RST}$  must be longer than 10us during Power ON sequence.

#### Power off sequence

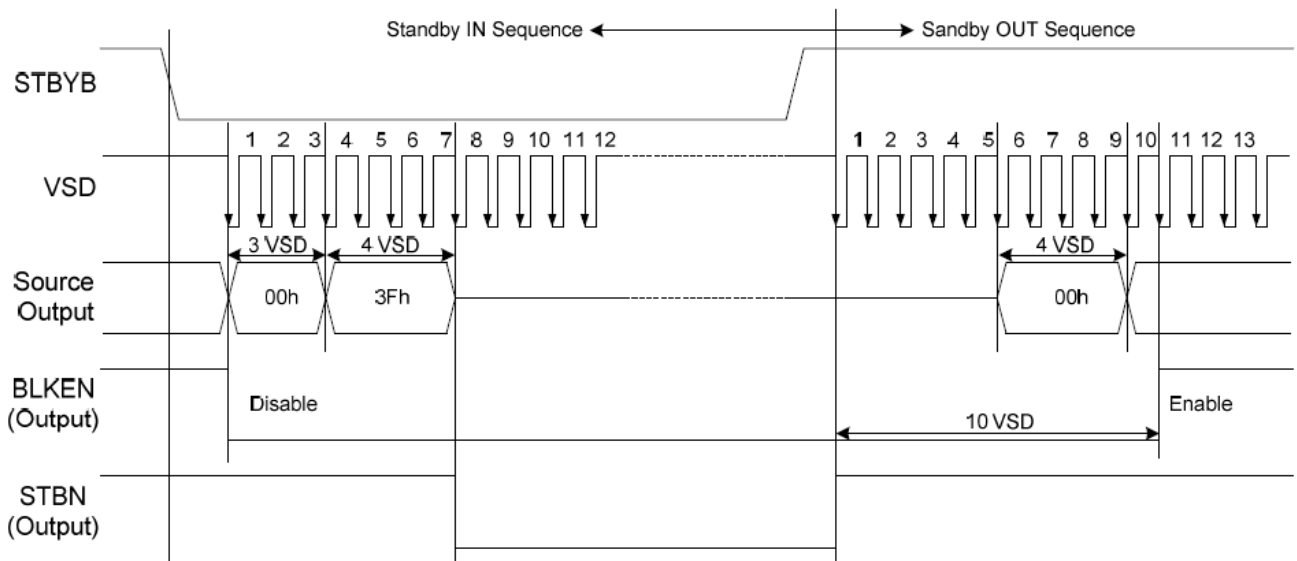

### 3.3. Timing Characteristics

#### 3.3.1. Sync Mode

### Horizontal Input Timing

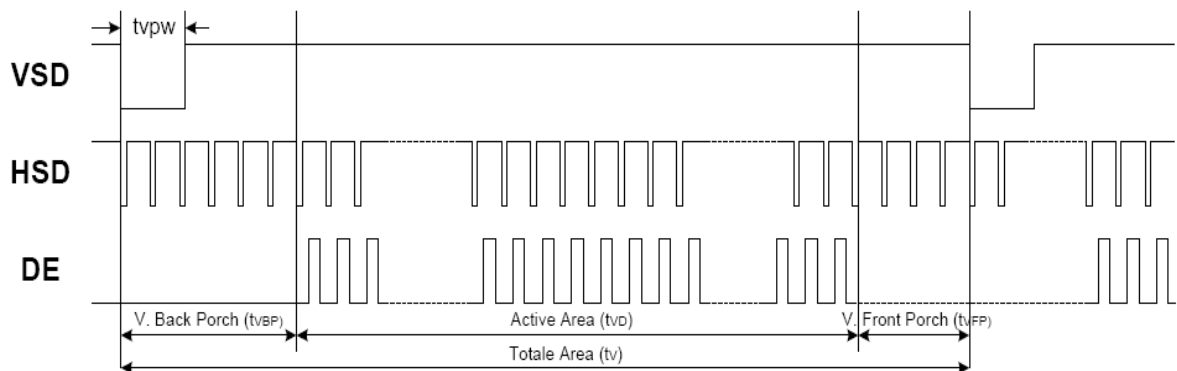
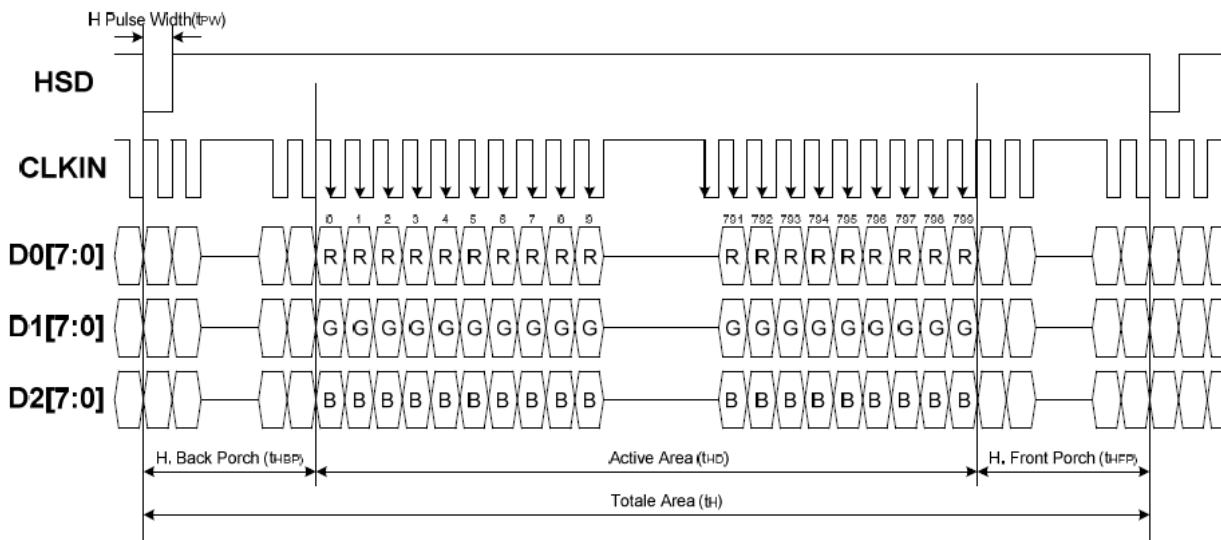

## 3.3.3. Timing

Item	Symbol	Values			Unit	Remark
		Min.	Typ.	Max.		
Horizontal Display Area	thd	-	800	-	DCLK	
DCLK Frequency	fclk	26.4	33.3	46.8	MHz	
One Horizontal Line	th	862	1056	1200	DCLK	
HS pulse width	thpw	1	-	40	DCLK	
HS Blanking	thb	46	46	46	DCLK	
HS Front Porch	thfp	16	210	354	DCLK	

Item	Symbol	Values			Unit	Remark
		Min.	Typ.	Max.		
Vertical Display Area	tvd	-	480	-	TH	
VS period time	tv	510	525	650	TH	
VS pulse width	tvpw	1	-	20	TH	
VS Blanking	tvb	23	23	23	TH	
VS Front Porch	tvfp	7	22	147	TH	

### 3.3.4. Data Input Format

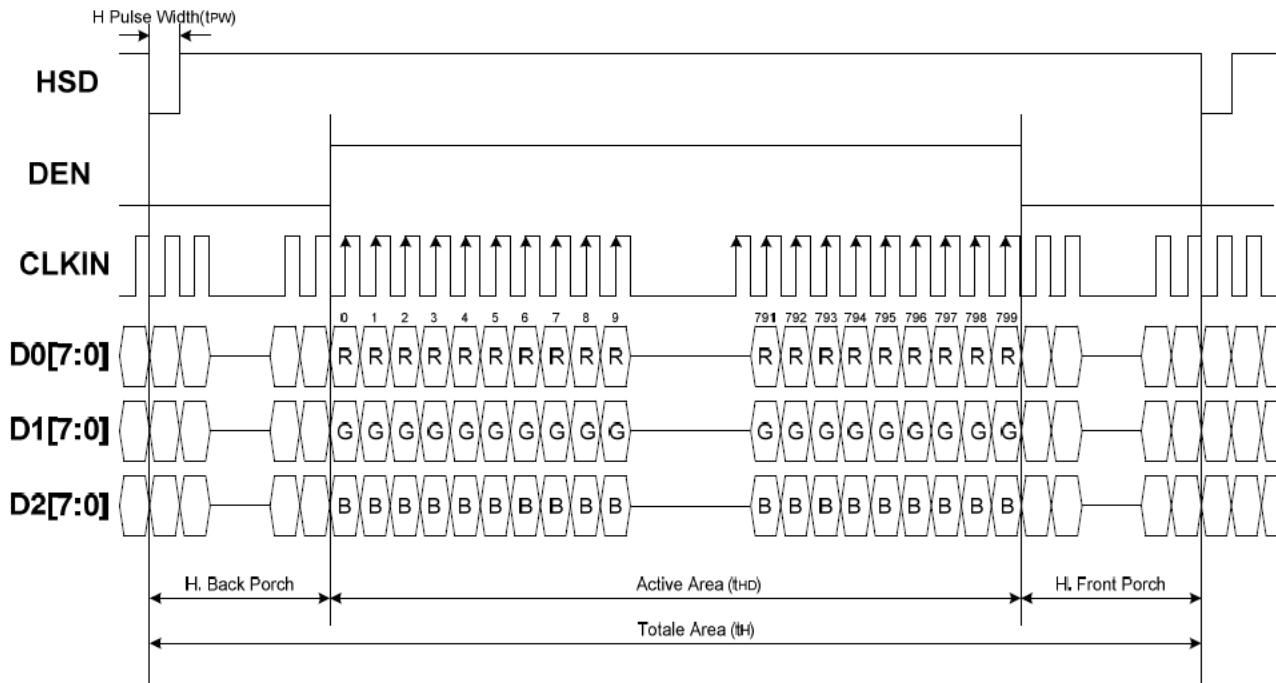

## 4. Optical Specifications

Item	Symbol	Condition	Values			Unit	Remark
			Min.	Typ.	Max.		
Viewing angle (CR≥ 10)	$\theta_L$	$\Phi=180^\circ$ (9 o'clock)	60	70	-	degree	Note 1
	$\theta_R$	$\Phi=0^\circ$ (3 o'clock)	60	70	-		
	$\theta_T$	$\Phi=90^\circ$ (12 o'clock)	40	50	-		
	$\theta_B$	$\Phi=270^\circ$ (6 o'clock)	60	70	-		
Response time	$T_{ON}$	Normal $\theta=\Phi=0^\circ$	-	10	20	msec	Note 3
	$T_{OFF}$		-	15	30	msec	Note 3
Contrast ratio	CR		400	500	-	-	Note 4
Color chromaticity	$W_X$		0.26	0.31	0.36	-	Note 2 Note 5
	$W_Y$		0.28	0.33	0.38	-	Note 6
Luminance	L		200	300	-	cd/m <sup>2</sup>	Note 6
Luminance uniformity	$Y_U$		70	75	-	%	Note 7

### Test Conditions:

1.  $DV_{DD}=3.3V$ ,  $I_L=270mA$  (Backlight current), the ambient temperature is  $25^\circ C$ .
2. The test systems refer to Note 2.

Note 1: Definition of viewing angle range

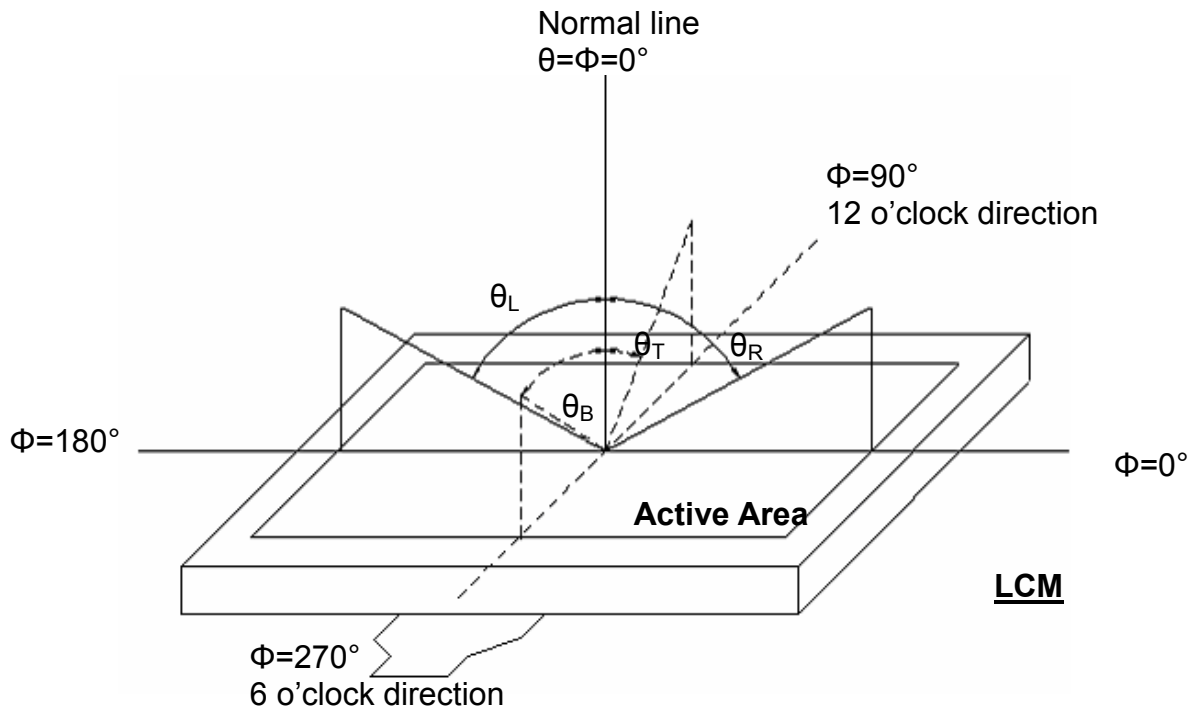

Fig. 4-1 Definition of viewing angle

Note 2: Definition of optical measurement system.

The optical characteristics should be measured in dark room. After 30 minutes operation, the optical properties are measured at the center point of the LCD screen. (Response time is measured by Photo detector TOPCON BM-7, other items are measured by BM-5A/Field of view:  $1^\circ$  /Height: 500mm.)

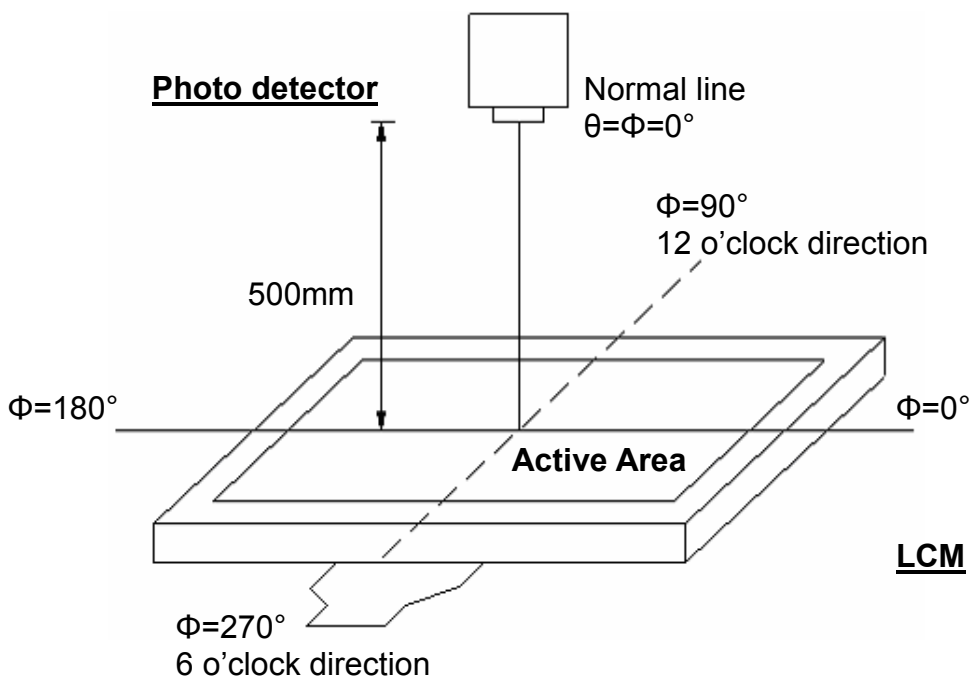

Fig. 4-2 Optical measurement system setup

Note 3: Definition of Response time

The response time is defined as the LCD optical switching time interval between "White" state and "Black" state. Rise time ( $T_{ON}$ ) is the time between photo detector output intensity changed from 90% to 10%. And fall time ( $T_{OFF}$ ) is the time between photo detector output intensity changed from 10% to 90%.

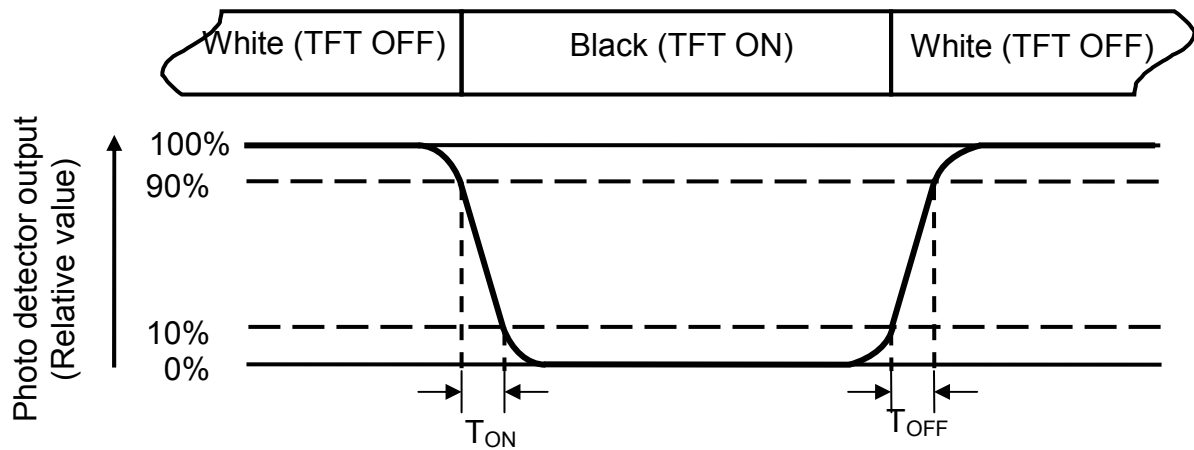

Fig. 4-3 Definition of response time

Note 4: Definition of contrast ratio

$$\text{Contrast ratio (CR)} = \frac{\text{Luminance measured when LCD on the "White" state}}{\text{Luminance measured when LCD on the "Black" state}}$$

Note 5: Definition of color chromaticity (CIE1931)

Color coordinates measured at center point of LCD.

Note 6: All input terminals LCD panel must be ground while measuring the center area of the panel. The LED driving condition is  $I_L=120\text{mA}$ .

Note 7: Definition of Luminance Uniformity

Active area is divided into 9 measuring areas (Refer to Fig. 4-4 ).Every measuring point is placed at the center of each measuring area.

$$\text{Luminance Uniformity (Yu)} = \frac{B_{min}}{B_{max}}$$

L-----Active area length      W----- Active area width

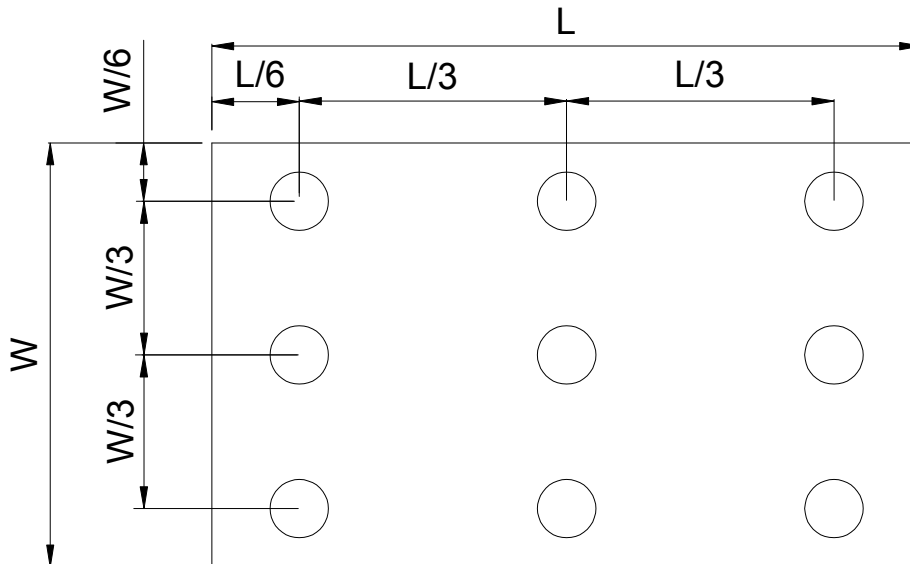

Fig. 4-4 Definition of measuring points

$B_{max}$ : The measured maximum luminance of all measurement position.

$B_{min}$ : The measured minimum luminance of all measurement position.



## 6. General Precautions

### 6.1. Safety

Liquid crystal is poisonous. Do not put it in your mouth. If liquid crystal touches your skin or clothes, wash it off immediately by using soap and water.

### 6.2. Handling

1. The LCD panel is plate glass. Do not subject the panel to mechanical shock or to excessive force on its surface.
2. The polarizer attached to the display is easily damaged. Please handle it carefully to avoid scratch or other damages.
3. To avoid contamination on the display surface, do not touch the module surface with bare hands.
4. Keep a space so that the LCD panels do not touch other components.
5. Put cover board such as acrylic board on the surface of LCD panel to protect panel from damages.
6. Transparent electrodes may be disconnected if you use the LCD panel under environmental conditions where the condensation of dew occurs.
7. Do not leave module in direct sunlight to avoid malfunction of the ICs.

### 6.3. Static Electricity

1. Be sure to ground module before turning on power or operating module.
2. Do not apply voltage which exceeds the absolute maximum rating value.

### 6.4. Storage

1. Store the module in a dark room where must keep at  $25\pm 10^{\circ}\text{C}$  and 65%RH or less.
2. Do not store the module in surroundings containing organic solvent or corrosive gas.
3. Store the module in an anti-electrostatic container or bag.

### 6.5. Cleaning

1. Do not wipe the polarizer with dry cloth. It might cause scratch.
2. Only use a soft sloth with IPA to wipe the polarizer, other chemicals might permanent damage to the polarizer.

All Pages Of This Edition Approved  
Signature: \_\_\_\_\_ Date: \_\_\_\_\_



靠左上角组靠左上角组装

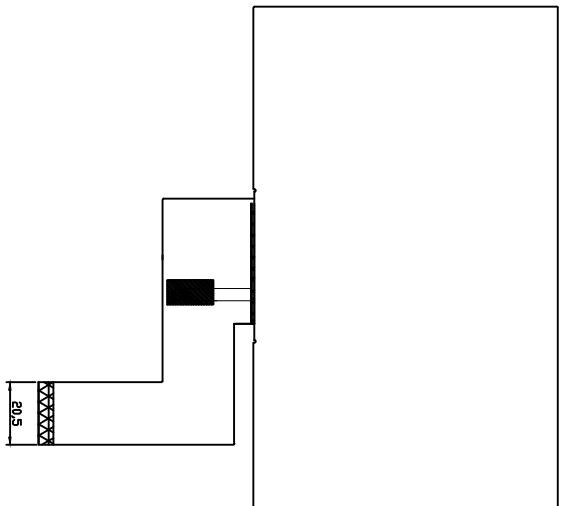
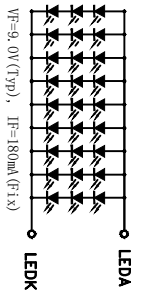
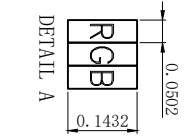
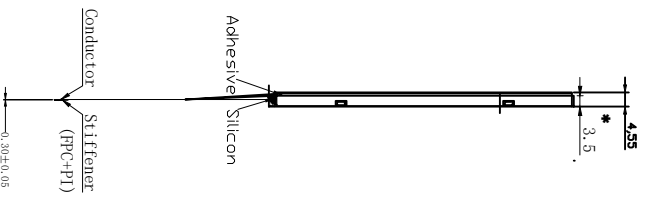
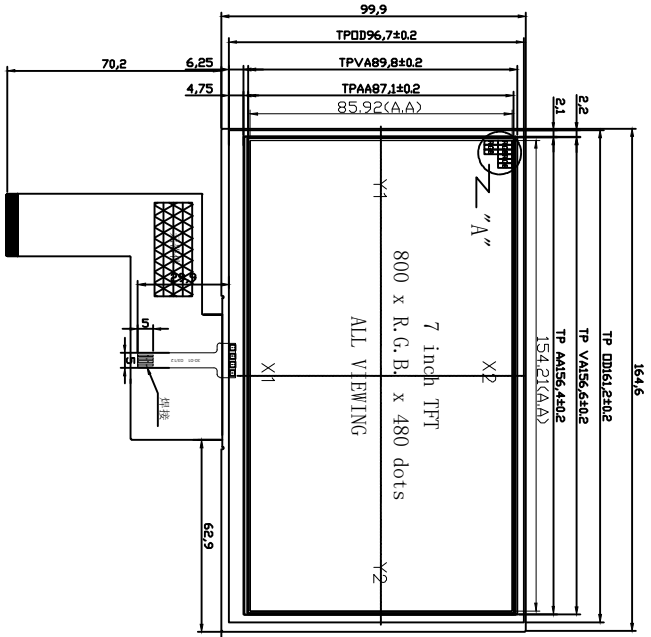

REV.	DESCRIPTION	REVISER	DATE
V0	NEW	ALECK	20201117
V1	修正BOMVA	ALECK	20201120

PIN	SYMBOL
1	VLED-
2	VLED+
3	GND
4	VDD
5	R0
6	R1
7	R2
8	R3
9	R4
10	R5
11	R6
12	R7
13	G0
14	G1
15	G2
16	G3
17	G4
18	G5
19	G6
20	G7
21	B0
22	B1
23	B2
24	B3
25	B4
26	B5
27	B6
28	B7
29	GND
30	DCLK
31	DISP
32	HSYNC
33	VSYNC
34	DE
35	NC
36	GND
37	NC/XR
38	
39	NC/VI
40	NC/YU

深圳市宇华微科技有限公司

- NOTES:
1. DISPLAY TYPE: 7.0" TN TFT T
  2. Luminance: 300 cd/m<sup>2</sup> (Type)
  3. Uniformity: 75% (Min) 80% (Type)
  4. OPERATING TEMP: -20° C~+70° C
  5. STORAGE TEMP: -30° C~+80° C
  6. UNMARKER TOLERANCE: ±0.20
  7. REQUIREMENTS ON ENVIRONMENTAL PROTECTION: RoHS

Unspecified Tolerance:	±0.20	UNITS: mm	DATE:	MODEL NUMBER:
DESIGN BY:				
CHECKED BY:				
APPROVED BY:				

PROJECTION	SHEET: 1 OF 1
DRAWING DESCRIPTION:	MODEL

## 8. Package Drawing

### 8.1. Packaging Material Table

No.	Item	Model (Material)	Dimensions(mm)	Unit Weight (kg)	Quantity	Remark
1	LCM Module	YH070RMD4001	164.9 × 100.0 × 4.55	0.150	55pcs	
2	Partition	BC Corrugated paper	512 × 349 × 226	1.466	1set	
3	Corrugated Paper	B Corrugated paper	510 × 350	0.071	4pcs	
4	Corrugated Bar	B Corrugated paper	512 × 11 × 3	0.046	4pcs	
5	Dust-Proof Bag	PE	700 × 530	0.048	1pcs	
6	A/S Bag	PE	180 × 133 × 0.2	0.002	60pcs	
7	Carton	Corrugated paper	530 × 355 × 255	1.100	1 pcs	
8	Total weight	10.682 kg ± 5%				

### 8.2. Packaging Quantity

Total LCM quantity in Carton: no. of Partition	2 Rows × quantity per Row 30	= 60
--	------------------------------	------

### 8.3. Packaging Drawing

