



**SPECIFICATION  
FOR  
LCD MODULE**

**Customer** : \_\_\_\_\_  
**Product Model:** YH080MH4001 V.1 +DBF  
**Sample code:** \_\_\_\_\_

Designed by	Checked by	Approved by

**Final Approval by Customer**

<input type="checkbox"/> <b>LCM Machinery OK</b> Checked By _____  <input type="checkbox"/> <b>LCM Display OK</b> Checked By _____	<input type="checkbox"/> <b>LCM OK</b>  <input type="checkbox"/> <b>NG , Problem survey:</b>  Approved By _____
--	---

※The specification of “TBD” should refer to the measured value of sample . If there is difference between the design specification and measured value, we naturally shall negotiate and agree to solution with customer.



# Contents

1. General Specifications .....	1
2. Pin Assignment .....	2
2.1. TFT LCD Panel Driving Section .....	2
3. Operation Specifications .....	5
3.1. Absolute Maximum Rating .....	5
3.1.1. Typical Operation Conditions .....	6
3.1.2. Current Consumption .....	6
3.2. Power Sequence .....	7
3.3. Timing Characteristics .....	8
3.3.1. AC Electrical Characteristics .....	8
3.3.2. Input Clock and Data Timing Diagram .....	8
3.3.3. DC Electrical Characteristics .....	9
3.3.4. Timing .....	10
3.3.5. Data Input Format .....	11
4. Optical Specifications .....	12
5. Reliability Test Items .....	16
6. General Precautions .....	17
6.1. Safety .....	17
6.2. Handling .....	17
6.3. Static Electricity .....	17
6.4. Storage .....	17
6.5. Cleaning .....	17
7. Mechanical Drawing .....	18

# 1. General Specifications

No.	Item	Specification	Remark
1	LCD size	8.0 inch(Diagonal)	
2	Driver element	a-Si TFT active matrix	
3	Resolution	1024 × 3(RGB) × 768	
4	Display mode	Normally Black, Transmissive	
5	Dot pitch	0.05275(W) × 0.15825(H) mm	
6	Active area	162.05(W) × 121.54(H) mm	
7	Panel size	174(W) × 136(H) × 2.6(D) mm	Note 1
8	Surface treatment	Hard coating	
9	Color arrangement	RGB-stripe	
10	View Direction(Gray Inversion)	IPS	
11	Interface	LVDS	
12	Panel power consumption	TBD (Typ.)	
13	Weight	TBD	

Note 1: Refer to Mechanical Drawing.

## 2. Pin Assignment

### 2.1. TFT LCD Panel Driving Section

FPC Connector is used for the module electronics interface. The recommended model is FH12A-40S-0.5SH manufactured by Hirose.

Pin No.	Symbol	I/O	Function	Remark
1	VCOM	P	Common Voltage	
2	VDD	P	Power Voltage for digital circuit	
3	VDD	P	Power Voltage for digital circuit	
4	NC	---	No connection	
5	Reset	I	Global reset pin	
6	STBYB	I	Standby mode, Normally pulled high STBYB = "1", normal operation STBYB = "0", timing controller, source driver will turn off, all output are High-Z	
7	GND	P	Ground	
8	RXIN0-	I	- LVDS differential data input	
9	RXIN0+	I	+ LVDS differential data input	
10	GND	P	Ground	
11	RXIN1-	I	- LVDS differential data input	
12	RXIN1+	I	+ LVDS differential data input	
13	GND	P	Ground	
14	RXIN2-	I	- LVDS differential data input	
15	RXIN2+	I	+ LVDS differential data input	
16	GND	P	Ground	
17	RXCLKIN-	I	- LVDS differential clock input	
18	RXCLKIN+	I	+ LVDS differential clock input	
19	GND	P	Ground	
20	RXIN3-	I	- LVDS differential data input	
21	RXIN3+	I	+ LVDS differential data input	
22	GND	P	Ground	
23	NC	---	No connection	

24	NC	---	No connection	
25	GND	P	Ground	
26	NC	---	No connection	
27	DIMO	O	Backlight CABC controller signal output	
28	SELB	I	6bit/8bit mode select	Note1
29	AVDD	P	Power for Analog Circuit	
30	GND	P	Ground	
31	LED-	P	LED Cathode	
32	LED-	P	LED Cathode	
33	L/R	I	Horizontal inversion	Note3
34	U/D	I	Vertical inversion	Note3
35	VGL	P	Gate OFF Voltage	
36	CABCEN1	I	CABC H/W enable	Note2
37	CABCEN0	I	CABC H/W enable	Note2
38	VGH	P	Gate ON Voltage	
39	LED+	P	LED Anode	
40	LED+	P	LED Anode	

I: input, O: output, P: Power

Note1: If LVDS input data is 6 bits ,SELB must be set to High;  
If LVDS input data is 8 bits ,SELB must be set to Low.

Note2: When CABC\_EN="00", CABC OFF.

When CABC\_EN="01", user interface image.

When CABC\_EN="10", still picture.

When CABC\_EN="11", moving image.

When CABC off, don't connect DIMO, else connect it to backlight.

Note3: When L/R="0", set right to left scan direction.

When L/R="1", set left to right scan direction.

When U/D="0", set top to bottom scan direction.

When U/D="1", set bottom to top scan direction.

Note: Definition of scanning direction.  
Refer to the figure as below:

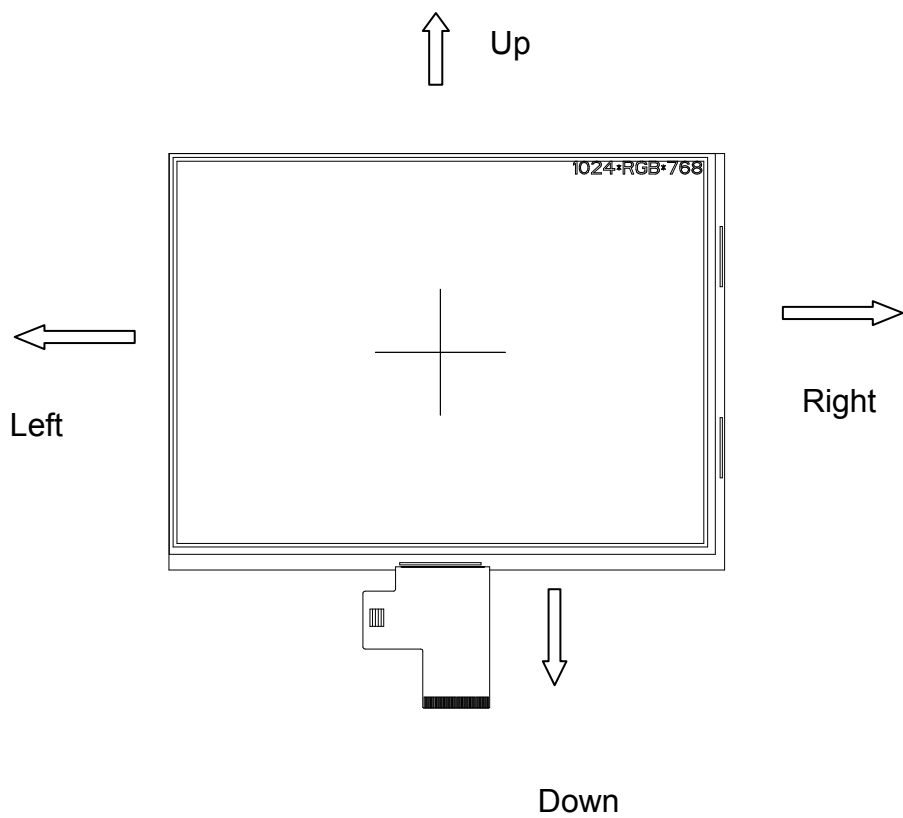

### 3. Operation Specifications

#### 3.1. Absolute Maximum Rating

(GND=AV<sub>SS</sub>=0V, Note 1)

Item	Symbol	Values		Unit	Remark
		Min.	Max.		
Power voltage	V <sub>CC</sub>	(-0.3)	(5.0)	V	
	AV <sub>DD</sub>	(6.5)	(13.5)	V	
	V <sub>GH</sub>	(-0.3)	(V <sub>GL</sub> +40)	V	
	V <sub>GL</sub>	(-20.0)	(0.3)	V	
	V <sub>GH</sub> -V <sub>GL</sub>	--	(40.0)	V	
Operation Temperature Storage Temperature	T <sub>OP</sub>	-10	60	°C	
	T <sub>ST</sub>	-20	70	°C	

Note 1: The absolute maximum rating values of this product are not allowed to be exceeded at any times. Should a module be used with any of the absolute maximum ratings exceeded, the characteristics of the module may not be recovered, or in an extreme case, the module may be permanently destroyed.

Item	Symbol	Values			Unit	Remark
		Min.	Typ.	Max.		
Voltage for LED backlight	V <sub>L</sub>	--	9.3	10.2	V	Note 1
Current for LED backlight	I <sub>L</sub>	--	220	--	mA	
LED life time	-	-	20,000	-	Hr	Note 2

Note 1: The LED Supply Voltage is defined by the number of LED at Ta=25°C and I<sub>L</sub>=220mA.

Note 2: The "LED life time" is defined as the module brightness decrease to 50% original brightness at Ta=25°C and I<sub>L</sub>=220mA. The LED lifetime could be decreased if operating I<sub>L</sub> is larger than 220mA.

### 3.1.1. Typical Operation Conditions

(GND=AV<sub>SS</sub>=0V, Note 1)

Item	Symbol	Values			Unit	Remark
		Min.	Typ.	Max.		
Power voltage	V <sub>CC</sub>	(3.0)	(3.3)	(3.6)	V	Note 2
	AV <sub>DD</sub>	(9.8)	(10)	(10.2)	V	
	V <sub>GH</sub>	(18.6)	(18.9)	(19.2)	V	
	V <sub>GL</sub>	(-8.1)	(-7.8)	(-7.5)	V	
Input signal voltage	V <sub>COM</sub>	(2.6)	(3.6)	(4.6)	V	Note 3
Input logic high voltage	V <sub>IH</sub>	(0.7V <sub>CC</sub> )	-	(V <sub>CC</sub> )	V	Note 4
Input logic low voltage	V <sub>IL</sub>	0	-	(0.3V <sub>CC</sub> )	V	

Note 1: Be sure to apply V<sub>CC</sub> and V<sub>GL</sub> to the LCD first, and then apply V<sub>GH</sub>.

Note 2: V<sub>CC</sub> setting should match the signals output voltage (refer to Note 3) of customer's system board .

Note 3: Typical V<sub>com</sub> is only a reference value, it must be optimized according to each LCM

Note 4: DCLK,HS,VS,RSTB,UPDN,STLR,MODE,DITHB.

### 3.1.2. Current Consumption

(GND=AV<sub>SS</sub>=0V)

Item	Symbol	Values			Unit	Remark
		Min.	Typ.	Max.		
Current for Driver	I <sub>GH</sub>		0.65	1.0	mA	V <sub>GH</sub> =18.9V
	I <sub>GL</sub>		0.65	1.0	mA	V <sub>GL</sub> =-7.8V
	I <sub>CC</sub>		35	60	mA	V <sub>CC</sub> =3.3V
	I <sub>AV<sub>DD</sub></sub>		25	40	mA	AV <sub>DD</sub> =10.0V

## 3.2. Power Sequence

### 3.2.1. Power on:

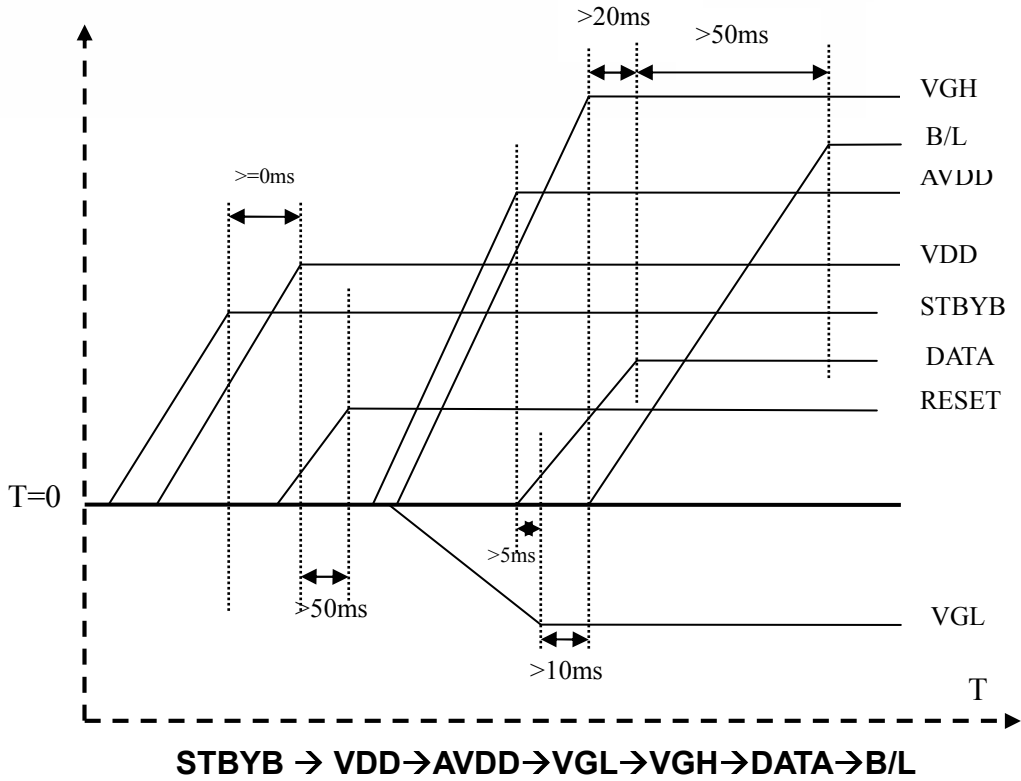

### 3.2.2. Power off:

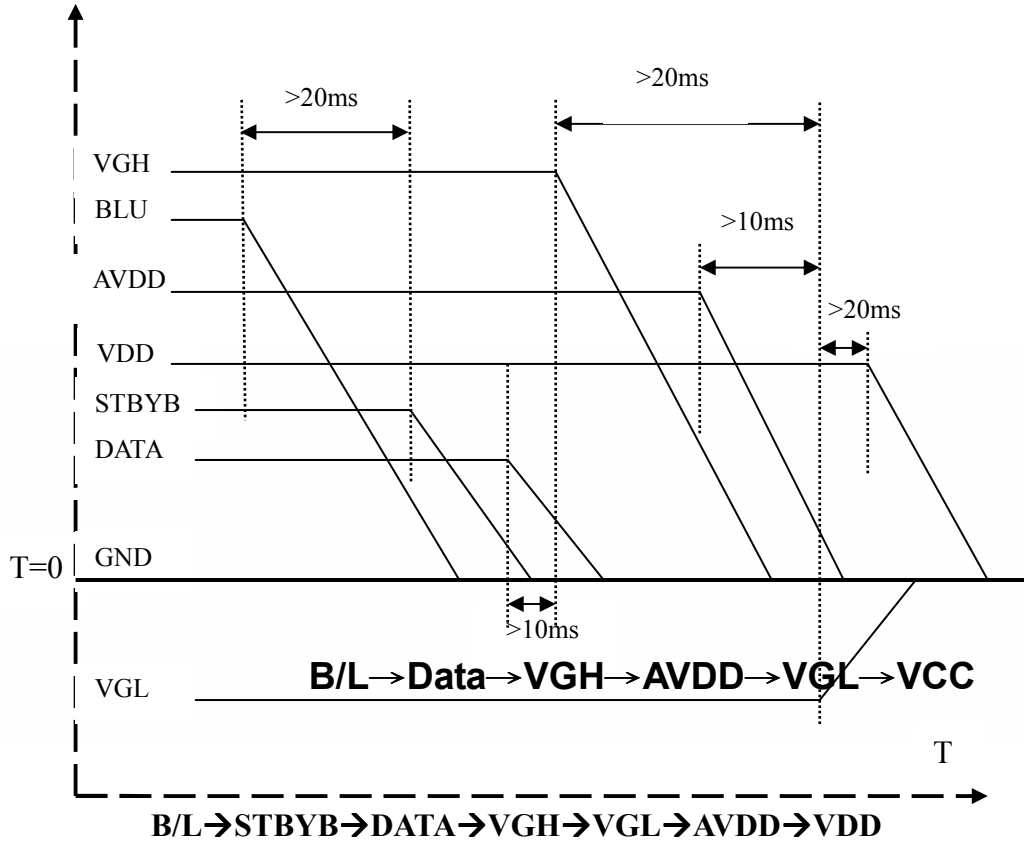

### 3.3. Timing Characteristics

#### 3.3.1. AC Electrical Characteristics

Parameter	Symbol	Values			Unit	Remark
		Min.	Typ.	Max.		
Clock frequency	$R_{xFCLK}$	20	-	71	MHz	
Input data skew margin	$T_{RSKM}$	500	-	-	ps	
Clock high time	$T_{LVCH}$	-	$4/(7 * R_{xFCLK})$	-	ns	
Clock low time	$T_{LVCL}$	-	$3/(7 * R_{xFCLK})$	-	ns	

#### 3.3.2. Input Clock and Data Timing Diagram

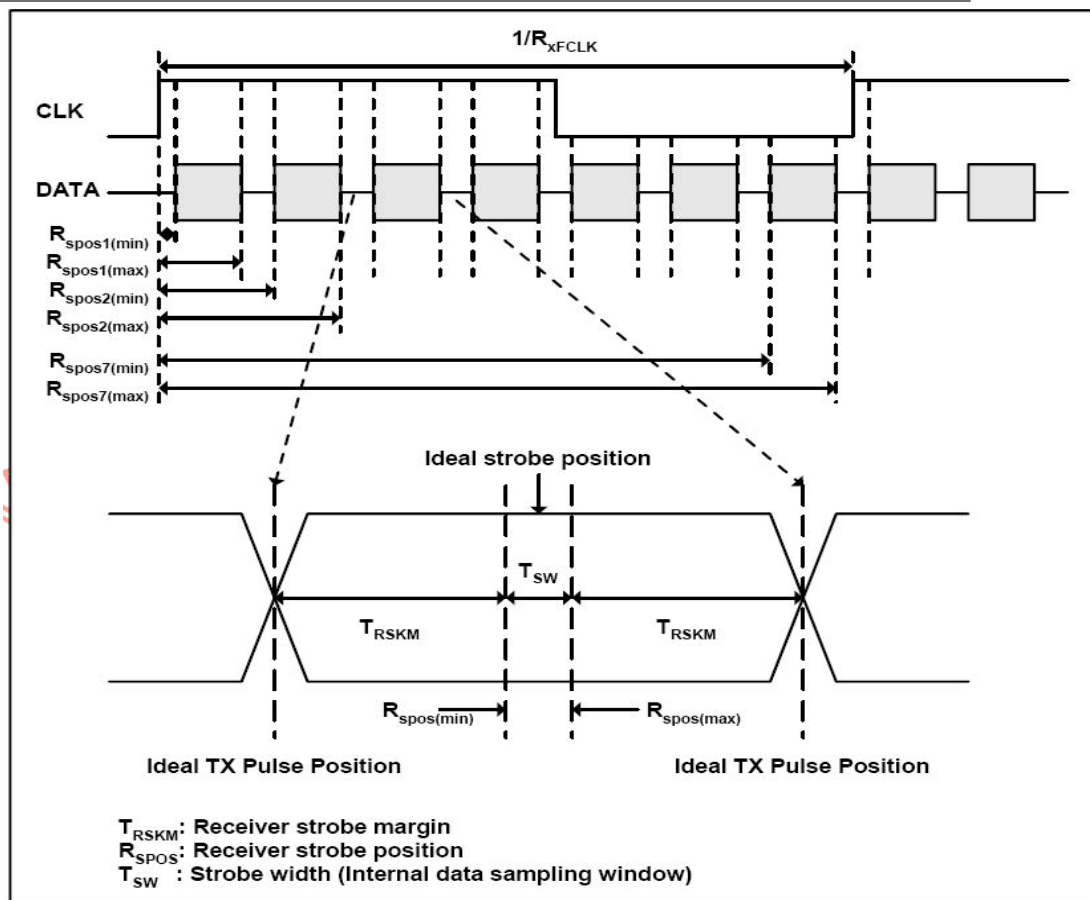
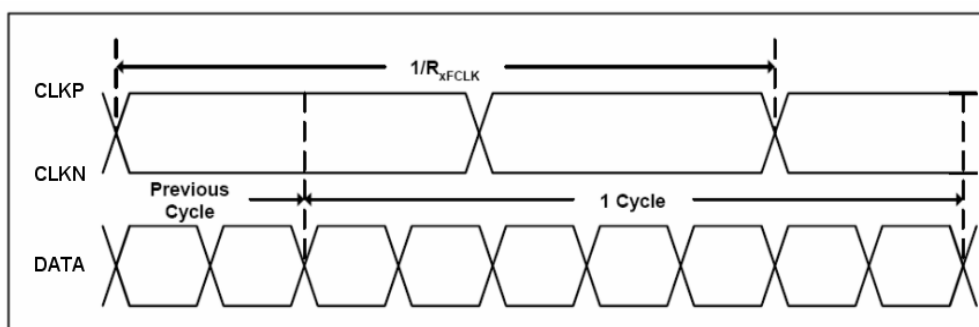

### 3.3.3. DC Electrical Characteristics

Parameter	Symbol	Values			Unit	Remark
		Min.	Typ.	Max.		
Differential input high Threshold voltage	$R_{xVTH}$	-	-	+0.1	V	$R_{xVCM}=1.2V$
Differential input low Threshold voltage	$R_{xVTH}$	-0.1	-	-	V	
Input voltage range (singled-end)	$R_{xVIN}$	0	-	2.4	V	
Differential input common mode voltage	$R_{xVCM}$	$ V_{ID} /2$	-	$2.4- V_{ID} /2$	V	
Differential voltage	$ V_{ID} $	0.2	-	0.6	V	
Differential input leakage current	$RV_{xIz}$	-10	-	+10	$\mu A$	

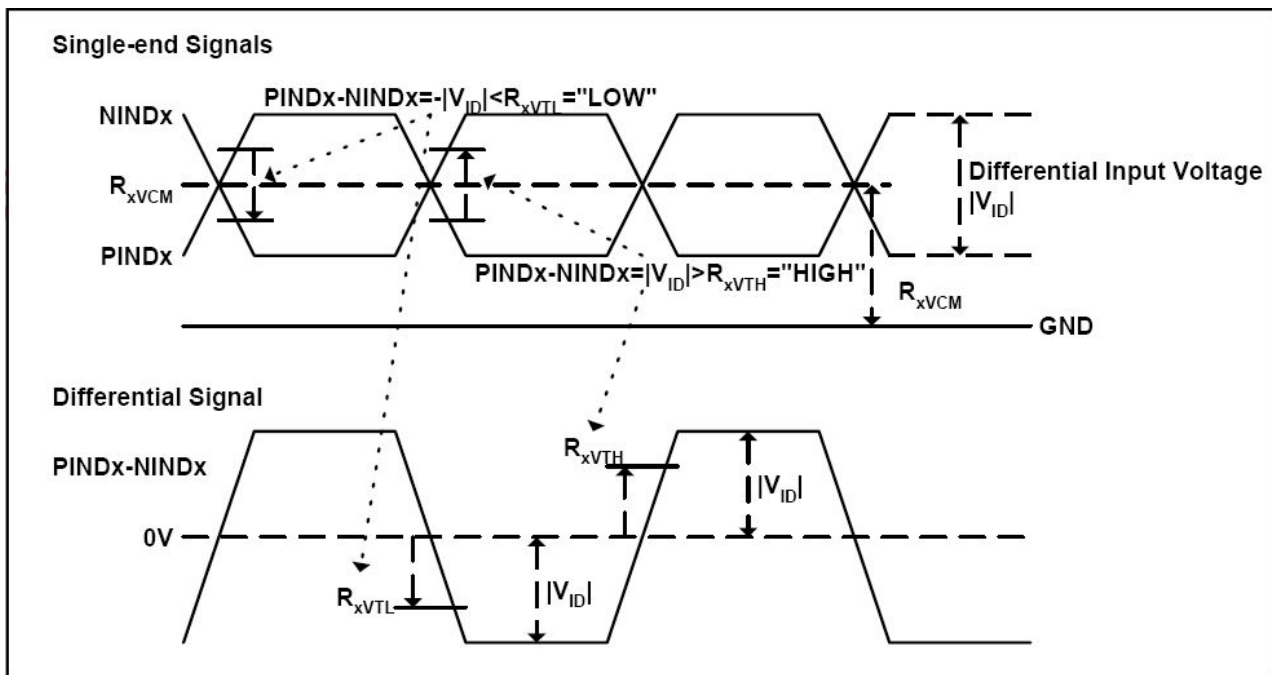

### 3.3.4. Timing

Item	Symbol	Values			Unit	Remark
		Min.	Typ.	Max.		
Clock Frequency	fclk	52	65	71	MHz	Frame rate
Horizontal display area	thd	1024			DCLK	
HS period time	th	1114	1344	1400	DCLK	
HS Blanking	thb	90	320	376	DCLK	
Vertical display area	tvd	768			H	
VS period time	tv	778	806	845	H	
VS Blanking	thb	10	38	77	H	

### 3.3.5. Data Input Format

#### 6bit LVDS input

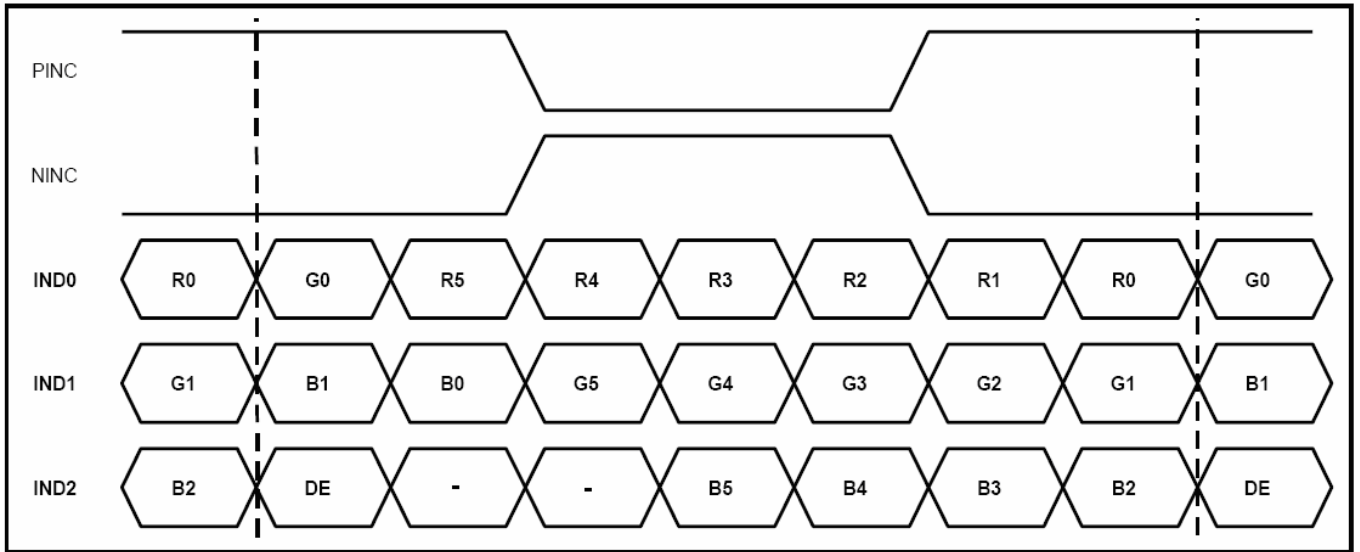

#### 8bit LVDS input

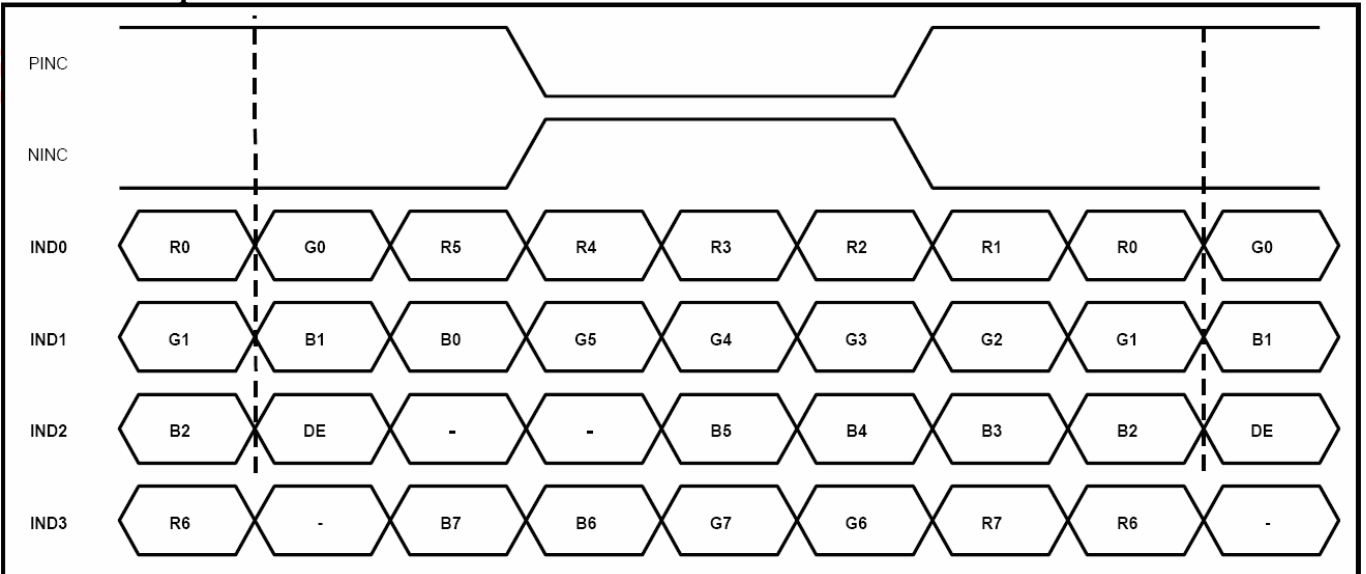

Note: Support DE timing mode only, SYNC mode not supported.

## 4. Optical Specifications

Item	Symbol	Condition	Values			Unit	Remark
			Min.	Typ.	Max.		
Viewing angle (CR $\geq$ 10)	$\theta_L$	$\Phi=180^\circ$ (9 o'clock)	75	85	-	degree	Note 1
	$\theta_R$	$\Phi=0^\circ$ (3 o'clock)	75	85	-		
	$\theta_T$	$\Phi=90^\circ$ (12 o'clock)	75	85	-		
	$\theta_B$	$\Phi=270^\circ$ (6 o'clock)	75	85	-		
Response time	$T_{ON}$	Normal $\theta=\Phi=0^\circ$	-	25	50	msec	Note 3
	$T_{OFF}$		-	14	28	msec	Note 3
Contrast ratio	CR		600	800	--		Note 4
Color chromaticity	$W_X$		0.238	0.288	0.388	-	Note 2
	$W_Y$		0.276	0.326	0.376	-	Note 5 Note 6
Luminance	L			350	400	-	cd/m <sup>2</sup>

Test Conditions:

1.  $V_{CC}=3.3V$ , the ambient temperature is  $25^\circ C$ .
2. The test systems refer to Note 2.

Note 1: Definition of viewing angle range

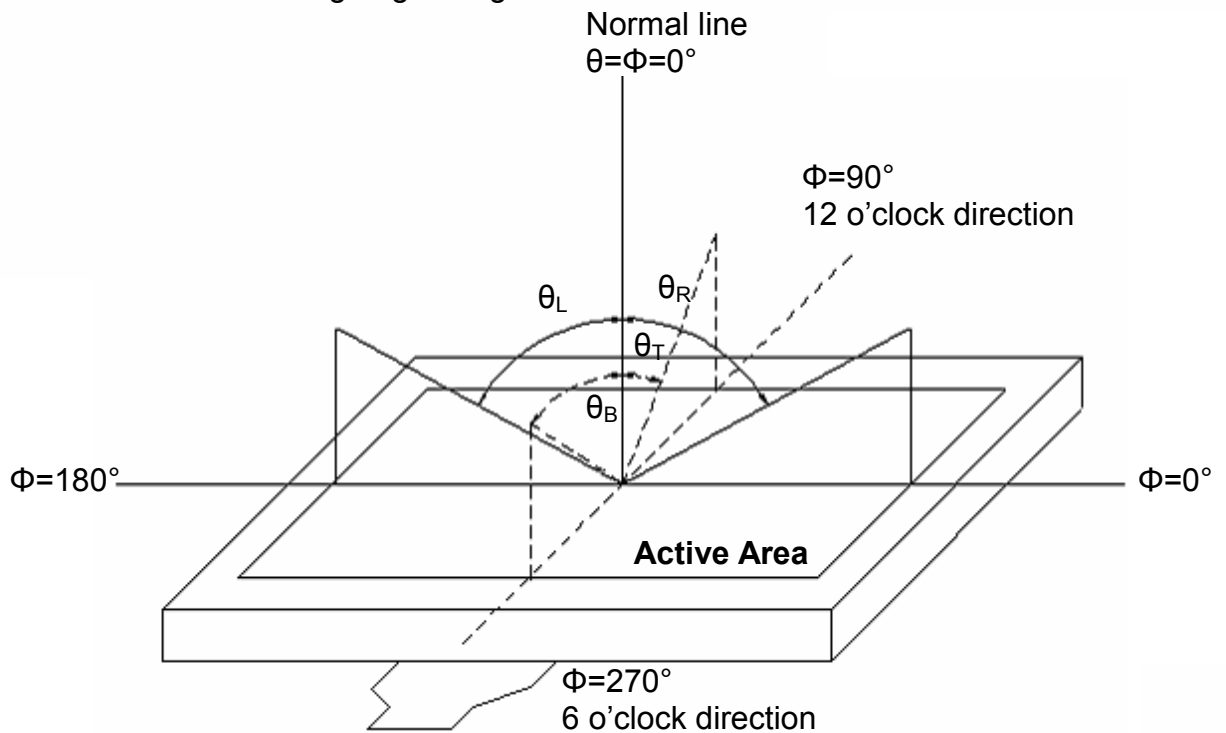

Fig. 4-1 Definition of viewing angle

Note 2: Definition of optical measurement system.

The optical characteristics should be measured in dark room. After 30 minutes operation, the optical properties are measured at the center point of the LCD screen. (Response time is measured by Photo detector TOPCON BM-7, other items are measured by BM-5A/Field of view:  $1^\circ$  /Height: 500mm.)

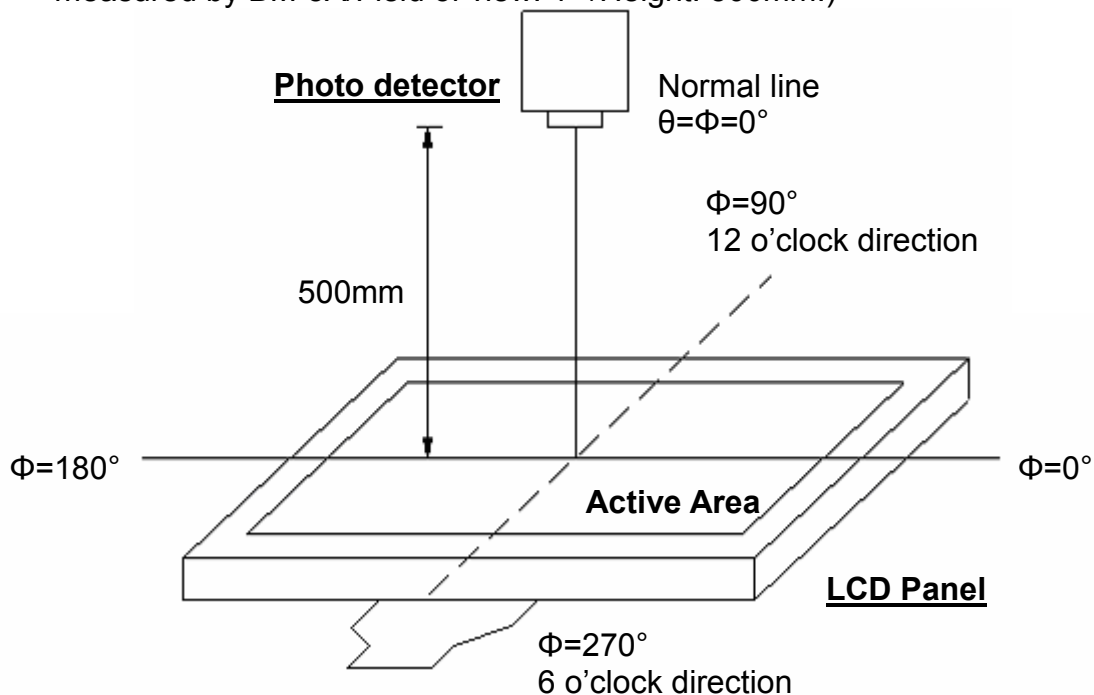

Fig. 4-2 Optical measurement system setup

Note 3: Definition of Response time

The response time is defined as the LCD optical switching time interval between "White" state and "Black" state. Rise time ( $T_{ON}$ ) is the time between photo detector output intensity changed from 90% to 10%. And fall time ( $T_{OFF}$ ) is the time between photo detector output intensity changed from 10% to 90%.

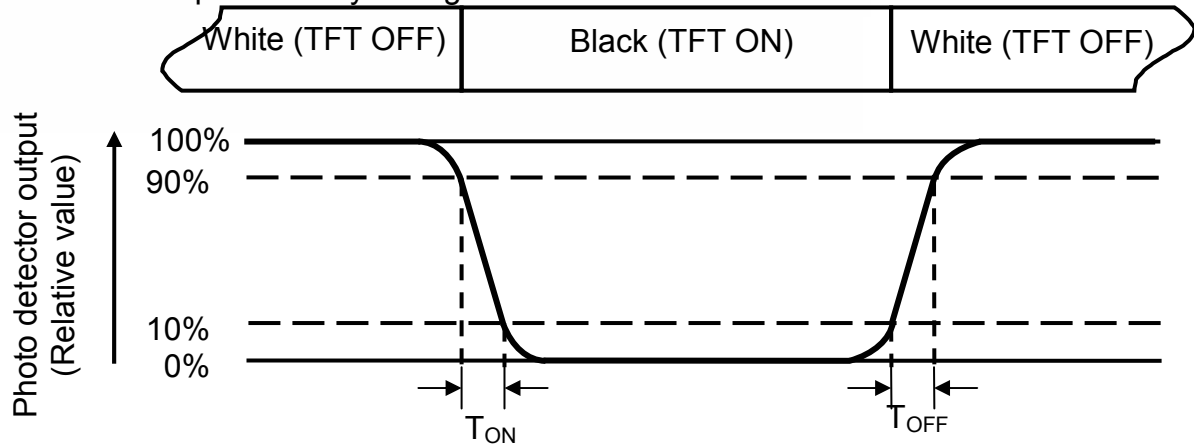

Fig. 4-3 Definition of response time

Note 4: Definition of contrast ratio

$$\text{Contrast ratio (CR)} = \frac{\text{Luminance measured when LCD on the "White" state}}{\text{Luminance measured when LCD on the "Black" state}}$$

Note 5: Definition of color chromaticity (CIE1931)

Color coordinates measured at center point of LCD.

Note 6: All input terminals LCD panel must be ground while measuring the center area of the panel.

Note 7: Definition of Luminance Uniformity

Active area is divided into 9 measuring areas (Refer to Fig. 4-4 ).Every measuring point is placed at the center of each measuring area.

$$\text{Luminance Uniformity (Yu)} = \frac{B_{min}}{B_{max}}$$

L-----Active area length      W----- Active area width

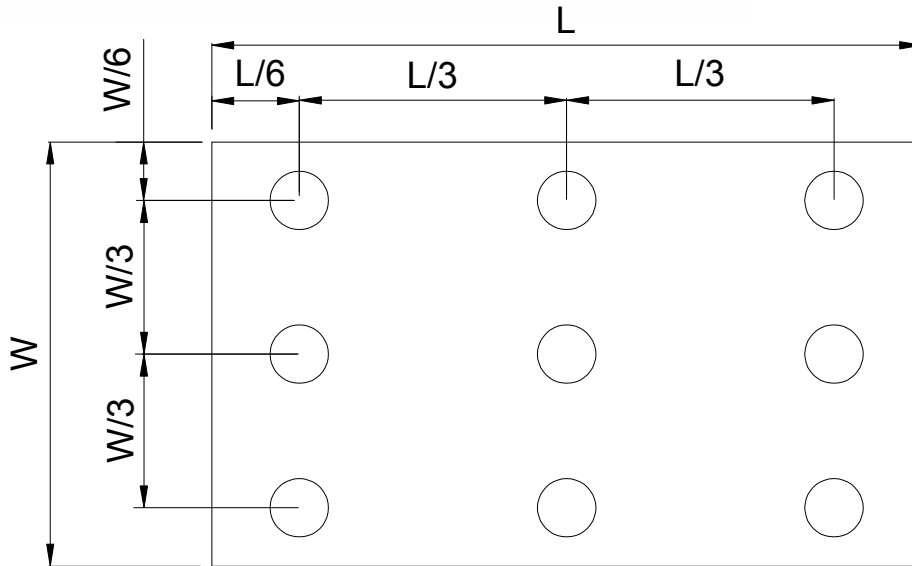

Fig. 4-4 Definition of measuring points

$B_{max}$ : The measured maximum luminance of all measurement position.

$B_{min}$ : The measured minimum luminance of all measurement position.

## 5. Reliability Test Items

(Note3)

Item	Test Conditions		Remark
High Temperature Storage	Ta = 80°C	240hrs	Note 1, Note 4
Low Temperature Storage	Ta = -20°C	240hrs	Note 1, Note 4
High Temperature Operation	Ts = 70°C	240hrs	Note 2, Note 4
Low Temperature Operation	Ta = -20°C	240hrs	Note 1, Note 4
Operate at High Temperature and Humidity	+40°C, 90%RH	240hrs	Note 4
Thermal Shock	-10°C/30 min ~ +60°C/30 min for a total 100 cycles, Start with cold temperature and end with high temperature.		Note 4

Note 1: Ta is the ambient temperature of samples.

Note 2: Ts is the temperature of panel's surface.

Note 3: In the standard condition, there shall be no practical problem that may affect the display function. After the reliability test, the product only guarantees operation, but don't guarantee all of the cosmetic specification.

Note 4: Before cosmetic and function test, the product must have enough recovery time, at least 2 hours at room temperature.

## 6. General Precautions

### 6.1. Safety

Liquid crystal is poisonous. Do not put it in your mouth. If liquid crystal touches your skin or clothes, wash it off immediately by using soap and water.

### 6.2. Handling

1. The LCD panel is plate glass. Do not subject the panel to mechanical shock or to excessive force on its surface.
2. The polarizer attached to the display is easily damaged. Please handle it carefully to avoid scratch or other damages.
3. To avoid contamination on the display surface, do not touch the module surface with bare hands.
4. Keep a space so that the LCD panels do not touch other components.
5. Put cover board such as acrylic board on the surface of LCD panel to protect panel from damages.
6. Transparent electrodes may be disconnected if you use the LCD panel under environmental conditions where the condensation of dew occurs.
7. Do not leave module in direct sunlight to avoid malfunction of the ICs.

### 6.3. Static Electricity

1. Be sure to ground module before turning on power or operating module.
2. Do not apply voltage which exceeds the absolute maximum rating value.

### 6.4. Storage

1. Store the module in a dark room where must keep at  $25\pm 10^{\circ}\text{C}$  and 65%RH or less.
2. Do not store the module in surroundings containing organic solvent or corrosive gas.
3. Store the module in an anti-electrostatic container or bag.

### 6.5. Cleaning

1. Do not wipe the polarizer with dry cloth. It might cause scratch.
2. Only use a soft sloth with IPA to wipe the polarizer, other chemicals might permanent damage to the polarizer.

修改	修改内容	日期

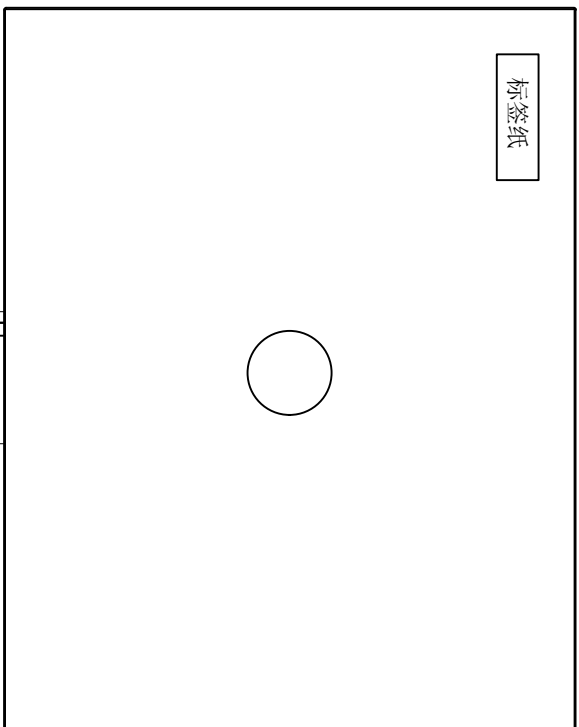
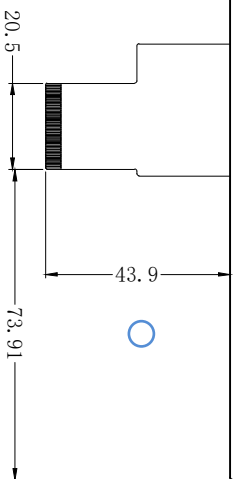
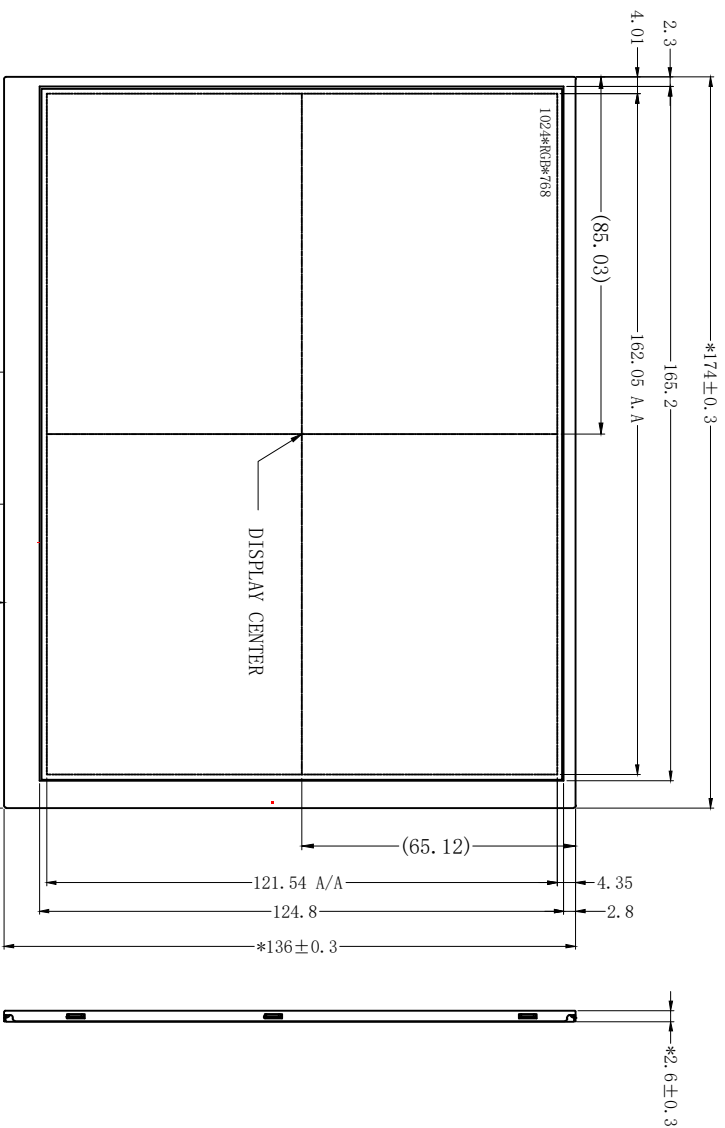

- Notes:
1. Unit: mm,
  2. Do not scale drawing.
  3. General tolerance:  $\pm 0.3$ .
  4. "△" Modification rev. number.
  5. \*For important dimension, () for reference dimension.
  6. REACH must be complied. (Use Lead-free process).
  7. Operating Temperature:  $-20^{\circ}+70^{\circ}$  C, Storage:  $-30^{\circ}+80^{\circ}$  C.

ITEM	SYMBOL	MIN	TYP	MAX	UNIT	NOTE
Luminous (LCM)	AVG	350	400	—	cd/m <sup>2</sup>	T=25° C
Chromaticity	X	0.26	—	0.31		所有测试
Coordinates	Y	0.25	—	0.30		误差为5%
Uniformity	MIN	75	80	%		以恒定电
Backlight voltage	VF	8.7	9.3	10.5	V	流测试。
Backlight current	IF	—	220	—	mA	

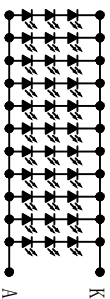

LED 3串11并9.3V 220mA

类型 (TYPE)	模组成品图
模组号 (MODEL NO)	YH080MH4001V.1
客户型号 (CST' S CODE)	

材料 (MATERIAL)	版本号 (EDITION)
	A
日期 (DATE)	2022.03.01

页次 (PAGE)	1/1	设计 (DESIGNED)
第三视角		核对 (CHECK)
		承认 (APPROVED)

深圳市宇华微科技有限公司  
Shenzhen Yuhua Wei Technology co., Ltd