

	PRODUCT GROUP	REV	ISSUE DATE
	TFT LCD PRODUCT	P0	2023.1.31

12.3inch MDL Product Pre-Specification

YHW123IPS-48A

Rev. P0

SPEC. NUMBER TBD	SPEC TITLE	PAGE 1 OF 21
---------------------	------------	-----------------

	PRODUCT GROUP	REV	ISSUE DATE
	TFT LCD PRODUCT	P0	2023.1.31

Contents

No.	Items	Page
1.0	General Description	4
2.0	Absolute Maximum Ratings	6
3.0	Electrical Specifications.	7
4.0	Optical Specifications.	8
5.0	Optical Test Appendix	10
6.0	Mechanical Characteristics	11
7.0	MDL Outline Dimension	12
8.0	Reliability Test	13
9.0	Interface Connection	14
10.0	Signal Specification	16
11.0	Power on/off Sequence	21
12.0	Package	23

SPEC. NUMBER TBD	SPEC TITLE	PAGE 3 OF 21
---------------------	------------	-----------------

1.0 GENERAL DESCRIPTION

1.1 Introduction

12.3inch module is a color active matrix TFT LCD module using amorphous silicon TFT' s (Thin Film Transistors) as an active switching devices. It is a transmissive type display operating in the normal black. The TFT-LCD has a 12.3 inch diagonally measured active area with resolutions (1920 horizontal by 720 vertical pixel arrays). Each pixel is divided into RED, GREEN, BLUE dots which are arranged in vertical stripe and this panel can display 16.7M colors.

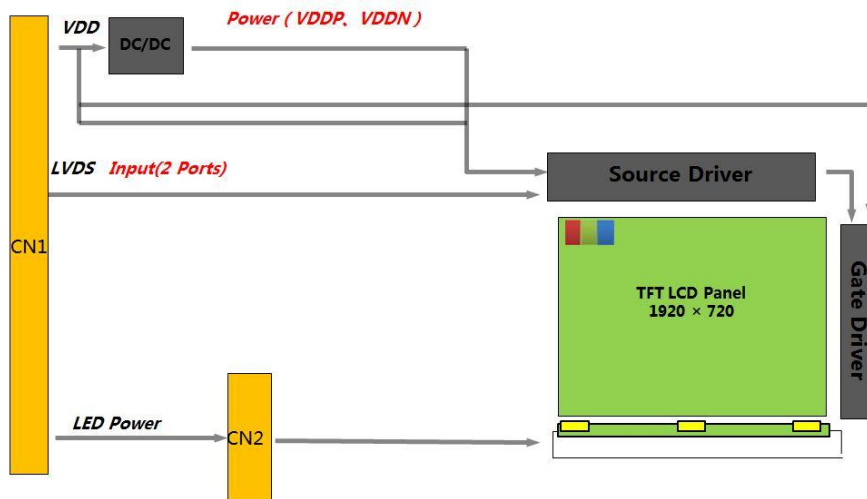

Figure 1-1 Block Diagram

1.2 Features

- Wide viewing angle (U/D/L/R) : 88/88/88/88
- Color Gamut : 70% Typ. On C-light
- Cell thickness : 1.0t
- LVDS Interface

1.3 Application

- **Vehicle-mounted Production**

PRODUCT GROUP

REV

ISSUE DATE

TFT LCD PRODUCT

P0

2023.1.31

1.4 General Specification

<Table 1-1 General Specifications>

Parameter	Specification	Unit	Remarks
Active area	292.032 (H) × 109.512 (V)	mm	8 : 3
Number of pixels	1920(H) ×720(V)	pixels	
Pixel pitch	0.1521(H) ×RGB×0.1521 (V)	mm	
Pixel arrangement	RGB Vertical stripe		
Display colors	16.7M	colors	
Color gamut	70%	%	C-light Typ.
Display mode	Normally black		
Viewing Direction (Human Eye)	U/D/L/R Min 80/80/80/80 Typ 88/88/88/88		
Surface Treatment	HC		CF&TFT Pol
Driver IC	3*FL5894 1*ST5086		Single gate 3S+1G

Note:

1. At the U/D/L/R direction, the viewing angle is same;
2. The TFT and CF Align Direction;

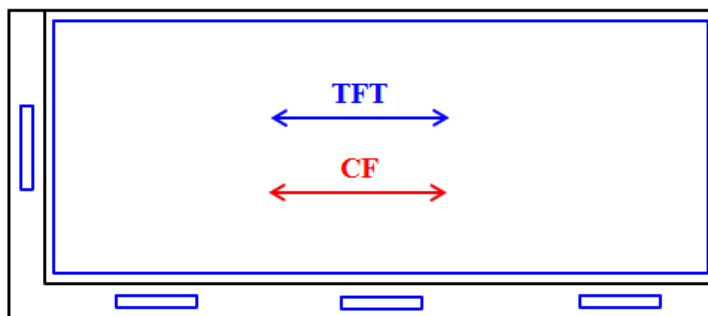

Figure 1-2 The TFT and CF Align Direction

SPEC. NUMBER
TBD

SPEC TITLE

PAGE
5 OF 21

	PRODUCT GROUP	REV	ISSUE DATE
	TFT LCD PRODUCT	P0	2023.1.31

2.0 ABSOLUTE MAXIMUM RATINGS

The followings are maximum values which, if exceed, may cause faulty operation or damage to the unit. The operational and non-operational maximum voltage and current values are listed in Table 2-1

< Table 2-1 Environment Absolute Maximum Ratings >

Parameter	Symbol	Min.	Max.	Unit	Remarks
LC operating Voltage *1)	V _{OP}	-	5.7	V	Ta=25+/-2°C
Operating Temperature (Humidity)	T _{OP}	-30	+80	°C	
	RH	-	90	%	At 60°C
Storage Temperature (Humidity)	T _{ST}	-30	+80	°C	
	RH	-	90	%	At 60°C

*1)Liquid Crystal driving voltage

Due to the characteristics of LC Material, this voltage varies with environmental temperature.

SPEC. NUMBER TBD	SPEC TITLE	PAGE 6 OF 21
---------------------	------------	-----------------

	PRODUCT GROUP	REV	ISSUE DATE
	TFT LCD PRODUCT	P0	2023.1.31

3.0 ELECTRICAL SPECIFICATIONS

3.1 Electrical Specifications

Ta=25+/-2°C

Parameter	Symbol	Values			Unit	Notes
		Min	Typ.	Max		
Voltage of VCC		3	-	3.6	V	
Current of VCC			350	550	mA	

Notes :

- 1: AVDD should be set to satisfy the characteristic of LC .
- 2: VGH should be set to satisfy charging ratio of TFT pixel.
- 3 : VCOM should be adjusted to make the flicker level be minimum and optimize display quality.
- 4: Frame rate=60HZ

SPEC. NUMBER TBD	SPEC TITLE	PAGE 7 OF 21
---------------------	------------	-----------------

	PRODUCT GROUP	REV	ISSUE DATE
	TFT LCD PRODUCT	P0	2023.1.31

4.0 OPTICAL SPECIFICATION

4.1 Overview

The test of Optical specifications shall be measured in a dark room (ambient luminance ≤ 1 lux and temperature = $25\pm 2^\circ\text{C}$) with the equipment of Luminance meter system (Goniometer system and TOPCON BM-5) and test unit shall be located at an approximate distance 50cm from the LCD surface at a viewing angle of θ and Φ equal to 0° . The center of the measuring spot on the Display surface shall stay fixed.

The backlight should be operating for 30 minutes prior to measurement.

<Table 4-1 Optical Specifications>

Parameter		Symbol	Condition	Min.	Typ.	Max.	Unit	Remark				
Viewing Angle range	Horizontal	Θ_3	CR > 10	80	88	-	Deg.	Note 1				
		Θ_9		80	88	-	Deg.					
	Vertical	Θ_{12}		80	88	-	Deg.					
		Θ_6		80	88	-	Deg.					
Luminance Contrast ratio		CR		-	1000	-						
White luminance uniformity		ΔY		-	-	-	%	Note 4				
NTSC		%		-	70%	-	%	@ c-light				
Transmittance		Tr.		3.25	3.65		%	@ c-light				
White Chromaticity		x_w	$\Theta = 0^\circ$ (Center) Normal Viewing Angle	Typ-0.03	0.296	Typ+0.03	-	TBD, update after locking spec Note 5				
		y_w			0.334		-					
Reproduction of color	Red	x_R			0.650		-					
		y_R			0.328		-					
	Green	x_G			0.330		-					
		y_G			0.625		-					
	Blue	x_B			0.146		-					
		y_B			0.058		-					
Response Time (Rising / Falling)		T_{RT}			25°C -20°C -30°C		-		-	30 250 500	ms	Note 6

SPEC. NUMBER TBD	SPEC TITLE	PAGE 8 OF 21
---------------------	------------	-----------------

	PRODUCT GROUP	REV	ISSUE DATE
	TFT LCD PRODUCT	P0	2023.1.31

Parameter	Condition	Min.	Typ.	Max.	Remark
Flicker	25°C	-	-	10%	@L127
Gamma	25°C	1.9	2.2	2.5	

Note :

- Viewing angle is the angle at which the contrast ratio is greater than 10. The viewing are determined for the horizontal or 3, 9 o'clock direction and the vertical or 6, 12 o'clock direction with respect to the optical axis which is normal to the LCD surface.
- Contrast measurements shall be made at viewing angle of $\theta = 0^\circ$ and at the center of the LCD surface. Luminance shall be measured with all pixels in the view field set first to white, then to the dark (black) state. (See FIGURE 1 shown in Appendix) Luminance Contrast Ratio (CR) is defined mathematically.

$$CR = \frac{\text{Luminance when displaying a white raster}}{\text{Luminance when displaying a black raster}}$$

- Center trans of white is defined as the LCD surface. Luminance shall be measured with all pixels in the view field set first to white. This measurement shall be taken at the locations shown in FIGURE 4 for a total of the measurements per display.
- The White luminance uniformity on LCD surface is then expressed as :
 $\Delta Y = (\text{Minimum Luminance of 9points} / \text{Maximum Luminance of 9points}) * 100$
- The color chromaticity coordinates specified in Table 4. shall be calculated from the spectral data measured with all pixels first in red, green, blue and white. Measurement condition is C - light source.
- The electro-optical response time measurements shall be made as FIGURE 5 shown in Appendix by switching the "data" input signal ON and OFF. The times needed for the transmittance to change from 10% to 90% is Tr, and 90% to 10% is Tf.

SPEC. NUMBER TBD	SPEC TITLE	PAGE 9 OF 21
---------------------	------------	-----------------

5.0 OPTICAL TEST APPENDIX

Figure 5-1 The Definition of Vth & Vsat

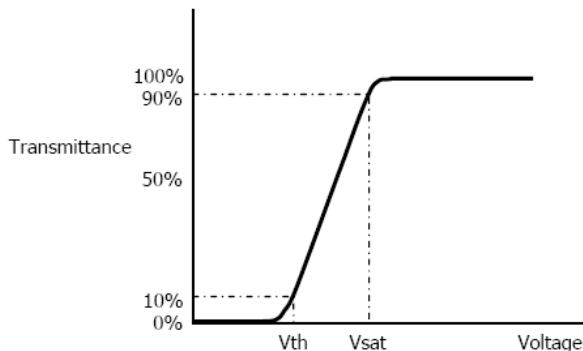

Figure 5-2 Measurement Set Up

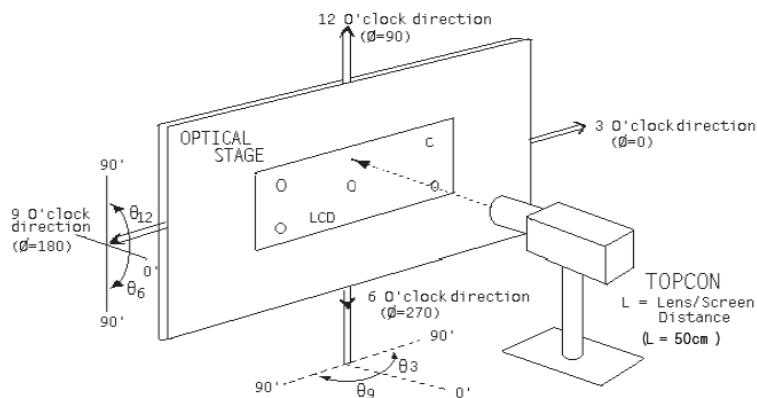
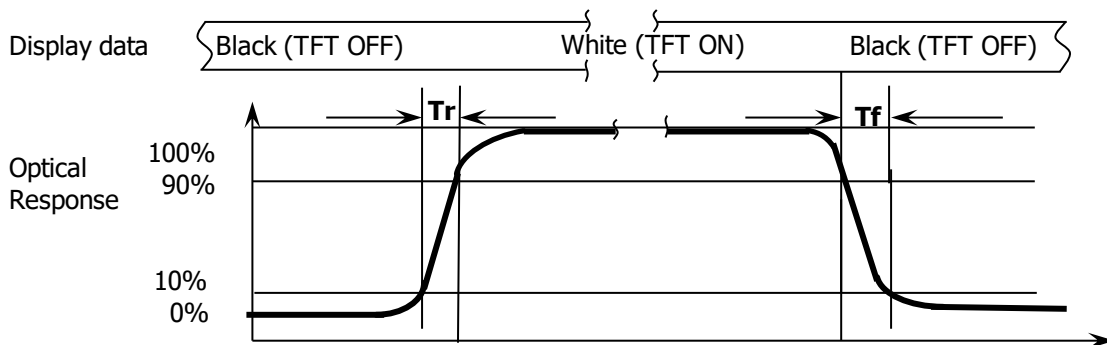

Figure 5-3 Response Time Testing



	PRODUCT GROUP	REV	ISSUE DATE
	TFT LCD PRODUCT	P0	2023.1.31

6.0 MECHANICAL CHARACTERISTICS

6.1 Dimensional Requirements

Figure in next page shows mechanical outlines for the panel

<Table 6-1 Dimensional Parameters>

Parameter	Specification	Unit
Active Area	292.032 (H) × 109.512 (V)	mm
Number of pixels	1920(H) × 720(V)	Pixels
Pixel pitch	0.1521(H) × RGB × 0.1521 (V)	mm
Pixel arrangement	RGB Vertical stripe	
Display colors	16.7M	colors
Display mode	Normally black	
FOB thickness	1.24	mm
FOG outline	300.2x119.7	mm
Outline Dimension	310(H) * 128(V) * 7(T)	mm

SPEC. NUMBER TBD	SPEC TITLE	PAGE 11 OF 21
---------------------	------------	------------------

7.0 MDL Outline Dimension

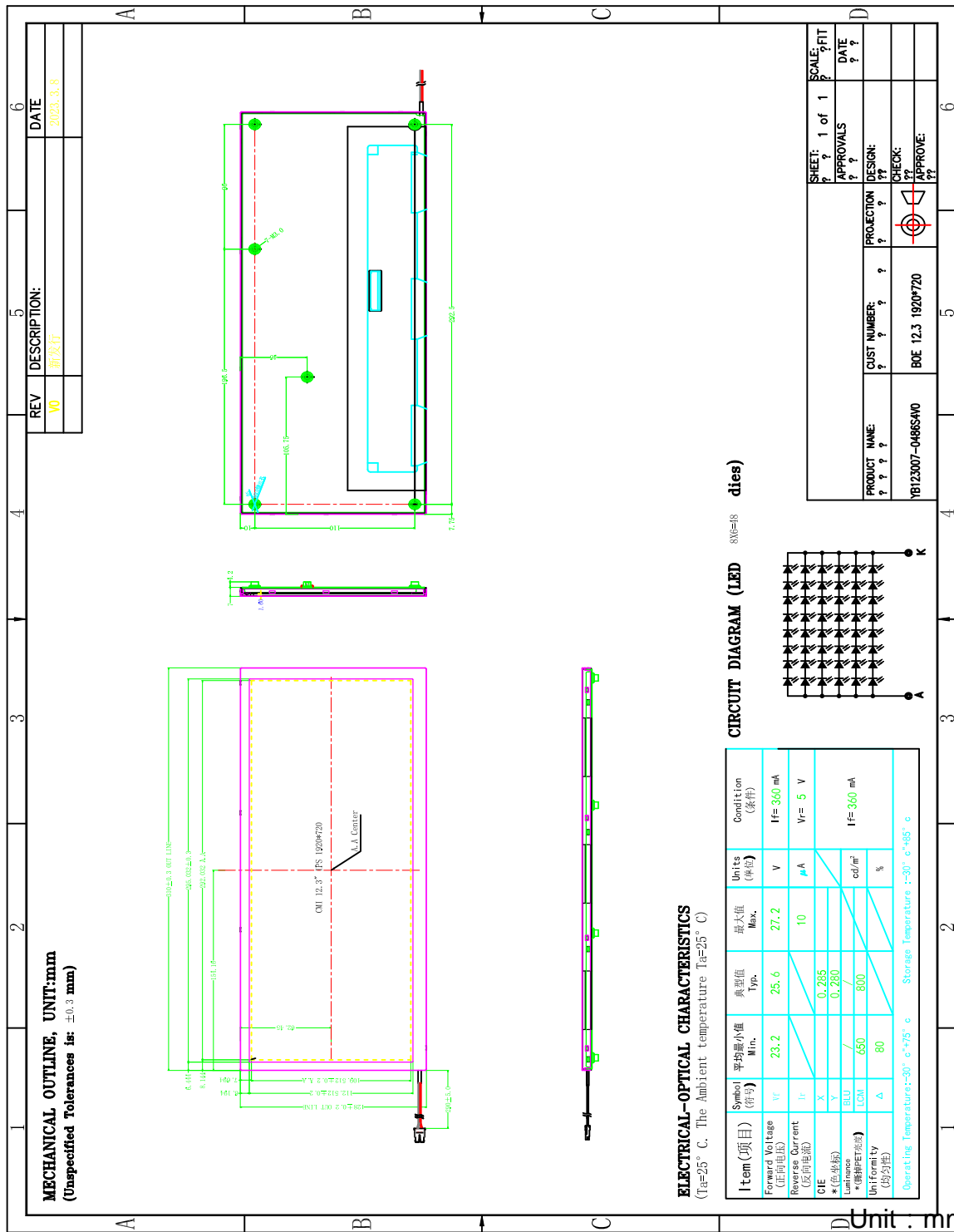

	PRODUCT GROUP	REV	ISSUE DATE
	TFT LCD PRODUCT	P0	2023.1.31

8.0 RELIABILITY TEST

<Table 8-1 Reliability test>

	Item	Unit	Required	Remark
1	运行温度	°C	-30°C~+80°C,240hrs	
2	存储温度	°C	-30°C~+80°C,240hrs	
3	ESD	KV	Air Voltage:± 6KV Contact Voltage:± 4KV R: 330Ω C: 150pF 5 time	Note
4	残像	-	Burn in:5*5 Chess,1h@25C. Inspection Pattern:50% grey, Perpendicular view, after 3min,the mura must disappear	
5	THO (高温高湿工作)	°C	Ta=+50°C, 80%RH, 240hrs	
6	TST (冷热冲击)	°C	-20°C(30min)~+60°C(30min) 100cycles(No Operation)	

Note

Class B, 有异常而可恢复, 比如闪屏

因为整机ESD水平不仅与模组相关, 也与系统相关。此处承诺配合客户整机达到要求, 如需要将进行ESD改善。

SPEC. NUMBER TBD	SPEC TITLE	PAGE 13 OF 21
---------------------	------------	------------------

PRODUCT GROUP

REV

ISSUE DATE

TFT LCD PRODUCT

P0

2023.1.31

9.0 INTERFACE CONNECTION**9.1 The LCD Module Electrical Interface Connection**

The Recommended connector is 101049-205050

The connector interface pin assignments are listed in Table 9-1

Table 9-1 Pin Assignments for the LCD Connector

PIN	SYMBOL	Description	Remark
1	NC	NO CONNECTION	BOE for VDDOTP
2	GND	Ground	
3	GND	Ground	
4	GND	Ground	
5	NC	NO CONNECTION	
6	VDD	Power Supply	
7	VDD	Power Supply	
8	VDD	Power Supply	
9	NC	NO CONNECTION	
10	NC	NO CONNECTION	BOE for ATREN
11	GND	Ground	
12	GND	Ground	
13	ORXIN0-	LVDS Receiver Signal(-)	
14	ORXIN0+	LVDS Receiver Signal(+)	
15	GND	Ground	
16	ORXIN1-	LVDS Receiver Signal(-)	
17	ORXIN1+	LVDS Receiver Signal(+)	
18	GND	Ground	
19	ORXIN2-	LVDS Receiver Signal(-)	
20	ORXIN2+	LVDS Receiver Signal(+)	
21	GND	Ground	
22	ORXCLKIN-	LVDS Receiver Signal(-)	
23	ORXCLKIN+	LVDS Receiver Signal(+)	
24	GND	Ground	

SPEC. NUMBER
TBD

SPEC TITLE

PAGE
14 OF 21

PRODUCT GROUP

REV

ISSUE DATE

TFT LCD PRODUCT

P0

2023.1.31

PIN	SYMBOL	Description	Remark
25	ORXIN3-	LVDS Receiver Signal(-)	
26	ORXIN3+	LVDS Receiver Signal(+)	
27	GND	Ground	
28	ERXIN0-	LVDS Receiver Signal(-)	
29	ERXIN0+	LVDS Receiver Signal(+)	
30	GND	Ground	
31	ERXIN1-	LVDS Receiver Signal(-)	
32	ERXIN1+	LVDS Receiver Signal(+)	
33	GND	Ground	
34	ERXIN2-	LVDS Receiver Signal(-)	
35	ERXIN2+	LVDS Receiver Signal(+)	
36	GND	Ground	
37	ERXCLKIN-	LVDS Receiver Signal(-)	
38	ERXCLKIN+	LVDS Receiver Signal(+)	
39	GND	Ground	
40	ERXIN3-	LVDS Receiver Signal(-)	
41	ERXIN3+	LVDS Receiver Signal(+)	
42	GND	Ground	
43	STBYB	STBYB Signal	L:Standby H:Normal
44	RESET	RESET Signal	L:Reset H:Normal
45	CSB	SPI Signal	
46	NC	NO CONNECTION	
47	SCL	SPI Signal	
48	SDA	SPI Signal	
49	NC	NO CONNECTION	
50	GND	Ground	

SPEC. NUMBER
TBD

SPEC TITLE

PAGE
15 OF 21

	PRODUCT GROUP	REV	ISSUE DATE
	TFT LCD PRODUCT	P0	2023.1.31

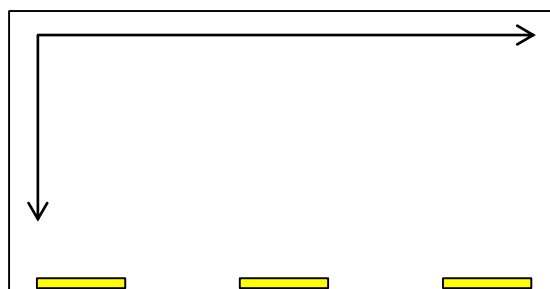

Figure 3-1 Scan direction Setting

10.0 SIGNAL SPECIFICATION

10.1 LVDS Signal Timing

Table 10-1 LVDS Signal Timing(DE Mode)

Parameter	Symbol	Min.	Typ.	Max.	Unit	Condition
Clock frequency	RxFCLK	43.1	45.7	70.1	MHz	Note1
Horizontal Display Area	thd	960			DCLK	
HS Period	th	989	1002	1248	DCLK	
HS Blanking	Thb+thfp		42		DCLK	
Vertical Display Area	tvd	720			TH	
VS Period	tv	727	760	936	TH	
VS Blanking	Tvbp+tvfp		40		TH	
Frame Rate	FR	60	60	60	Hz	
Clock period	TLVCYC	14.28			ns	
Clock high time	TLVCH		4		UI	
Clock low time	TLVCL		3		UI	
LVDS wake-up time	T_{ENLVDS}			150	us	

Note 1: Advise the customer to use the Typ. value

SPEC. NUMBER TBD	SPEC TITLE	PAGE 16 OF 21
---------------------	------------	------------------

PRODUCT GROUP

REV

ISSUE DATE

TFT LCD PRODUCT

P0

2023.1.31

10.2 Signal Format

Table 10-2 2-port LVDS signals, VESA format, 8-bit mode



Note:

1. For 6 bit mode, MSB are R/G/B[5] and LSB are R/G/B[0]
2. For 8 bit mode, MSB are R/G/B[7] and LSB are R/G/B[0]
3. For single port LVDS only ODD port (CLKxO and DxxO) are used

SPEC. NUMBER
TBD

SPEC TITLE

PAGE
17 OF 21

10.3 Parallel RGB at DE only mode

Vertical input timing

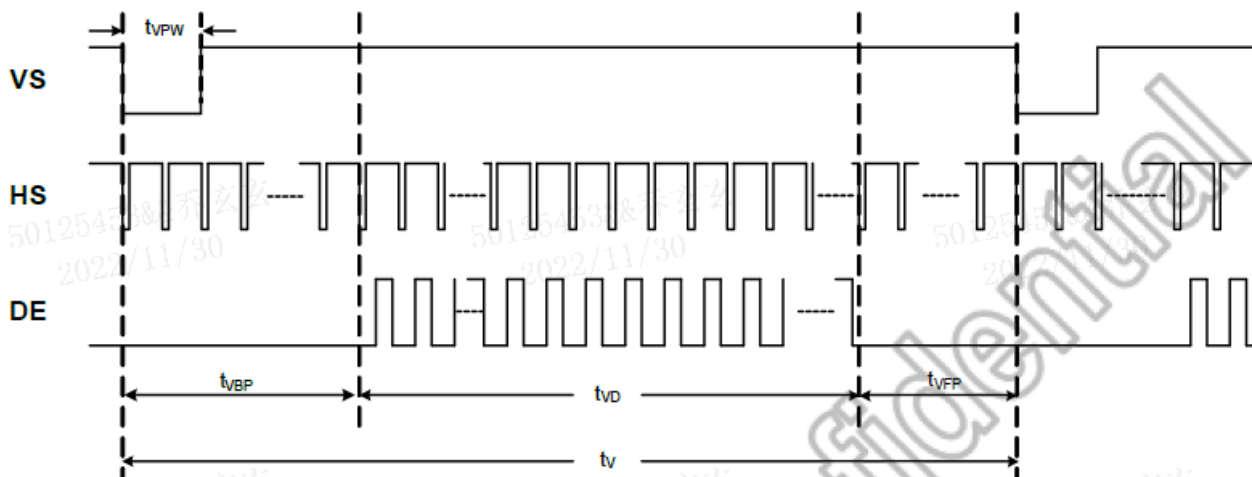

Horizontal input timing

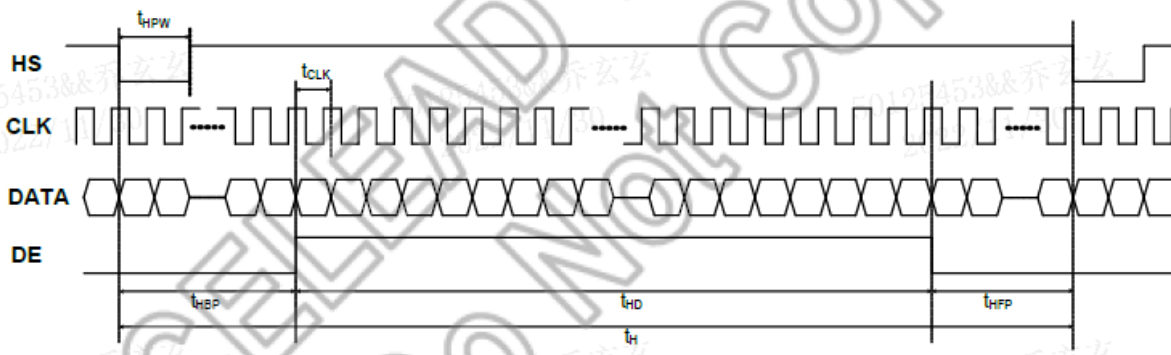

10.4 LVDS DC Characteristics

Table 10-4 LVDS DC Characteristics

Parameter	Symbol	Min	Typ.	Max.	Unit	Conditions
Differential input high threshold voltage	R_{xVTH}			0.1	V	$R_{xVCM} = 1.2V$
Differential input low threshold voltage	R_{xVTL}	-0.1			V	
Input voltage range (singled-end)	R_{xVIN}	0		$V_{DD}-1.2$	V	
Differential input common mode voltage	R_{xVCM}	0.8	1.2	1.4	V	
Differential input voltage	$ V_{ID} $	0.2	0.4	0.6	V	
Differential input leakage current	$R_{V_{xIz}}$	-10		10	μA	

Differential signals

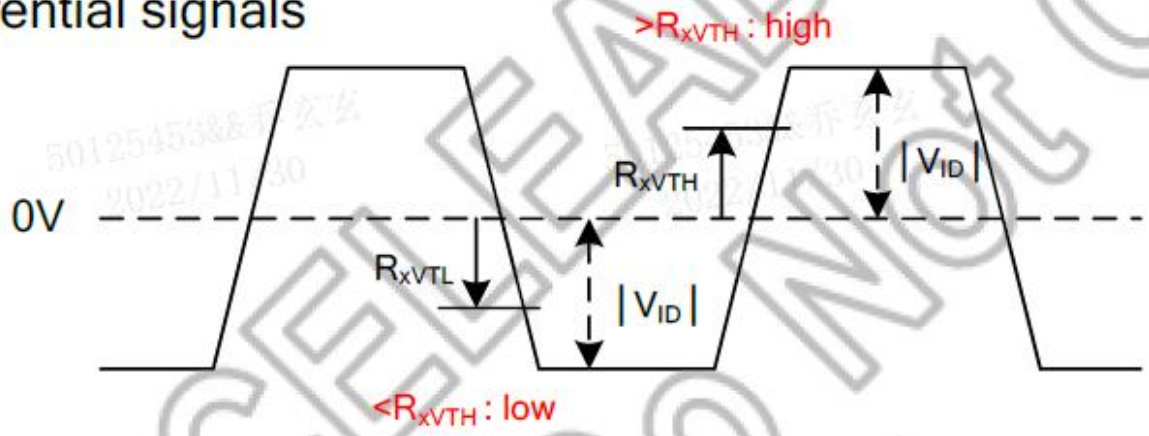

10.5 LVDS AC Characteristics

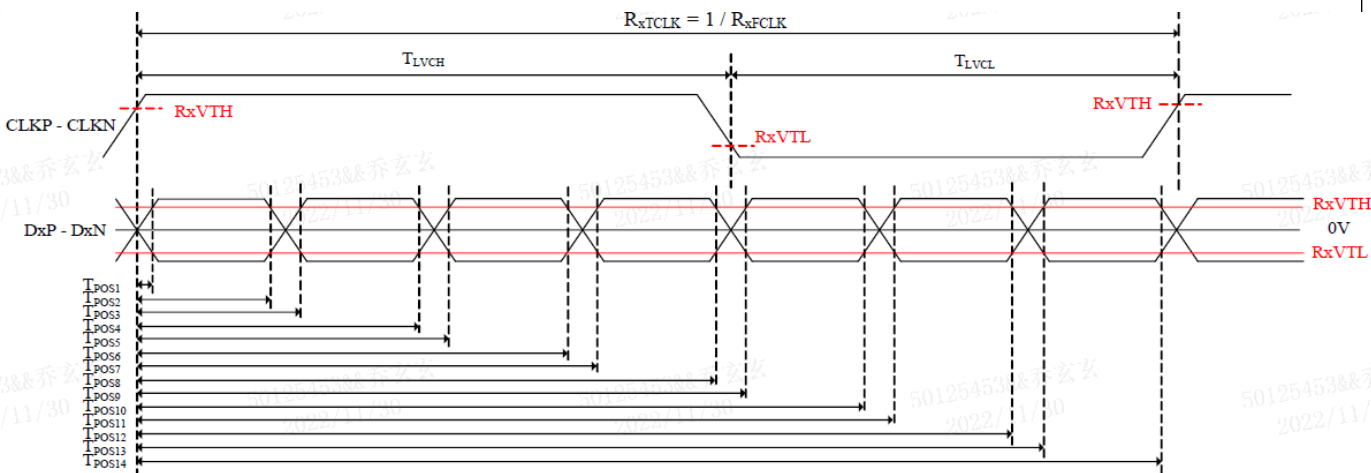

PRODUCT GROUP

REV

ISSUE DATE

TFT LCD PRODUCT

P0

2023.1.31

Parameter	Symbol	Min	Typ.	Max.	Unit
Clock Frequency	R _x FCLK	20		90	MHz
Clock Period	R _x TCLK	11.1		50	ns
1 data bit time	UI	-	1/7	-	R _x TCLK
Clock high time	T _{LVCH}		4		UI
Clock low time	T _{LVCL}		3		UI
Position 1	T _{POS1}	-0.25	0	0.25	UI
Position 2	T _{POS2}	0.75	-	1.25	UI
Position 3	T _{POS3}	0.75	1	1.25	UI
Position 4	T _{POS4}	1.75	-	2.25	UI
Position 5	T _{POS5}	1.75	2	2.25	UI
Position 6	T _{POS6}	2.75	-	3.25	UI
Position 7	T _{POS7}	2.75	3	3.25	UI
Position 8	T _{POS8}	3.75	-	4.25	UI
Position 9	T _{POS9}	3.75	4	4.25	UI
Position 10	T _{POS10}	4.75	-	5.25	UI
Position 11	T _{POS11}	4.75	5	5.25	UI
Position 12	T _{POS12}	5.75	-	6.25	UI
Position 13	T _{POS13}	5.75	6	6.25	UI
Position 14	T _{POS14}	6.75	-	7.25	UI
Input eye width	T _{EYEW}	0.5	-	-	UI
Input eye border	T _{EX}	-	-	0.25	UI
PLL wake-up time	T _{enPLL}			150	us

Table 10-5 LVDS AC Characteristics

SPEC. NUMBER
TBD

SPEC TITLE

PAGE
20 OF 21

11.0 POWER ON/OFF SEQUENCE

11.1 POWER ON SEQUENCE

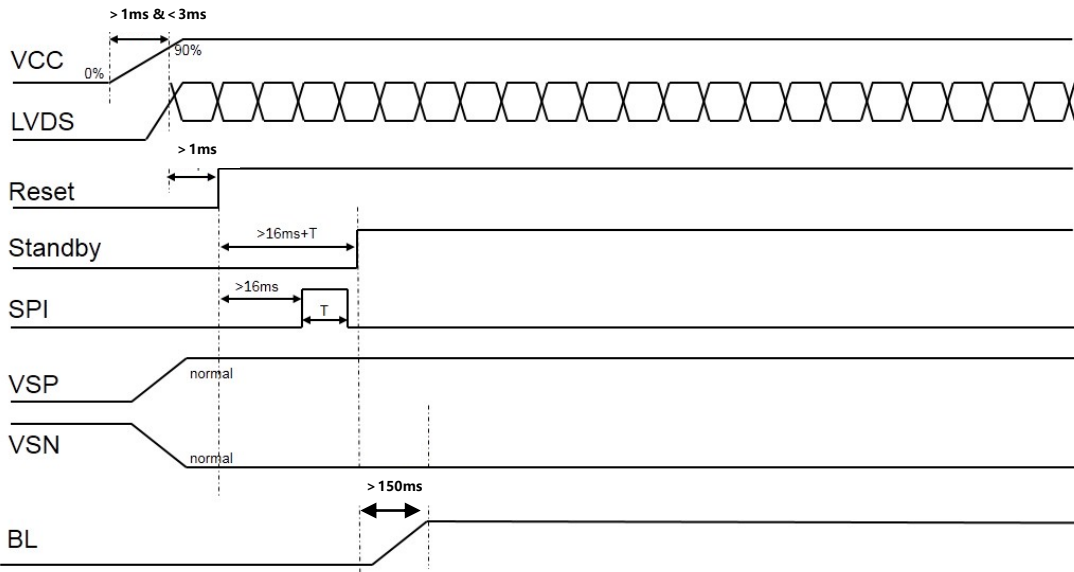

PRODUCT GROUP

REV

ISSUE DATE

TFT LCD PRODUCT

P0

2023.1.31

11.0 POWER ON/OFF SEQUENCE

11.2 POWER OFF SEQUENCE

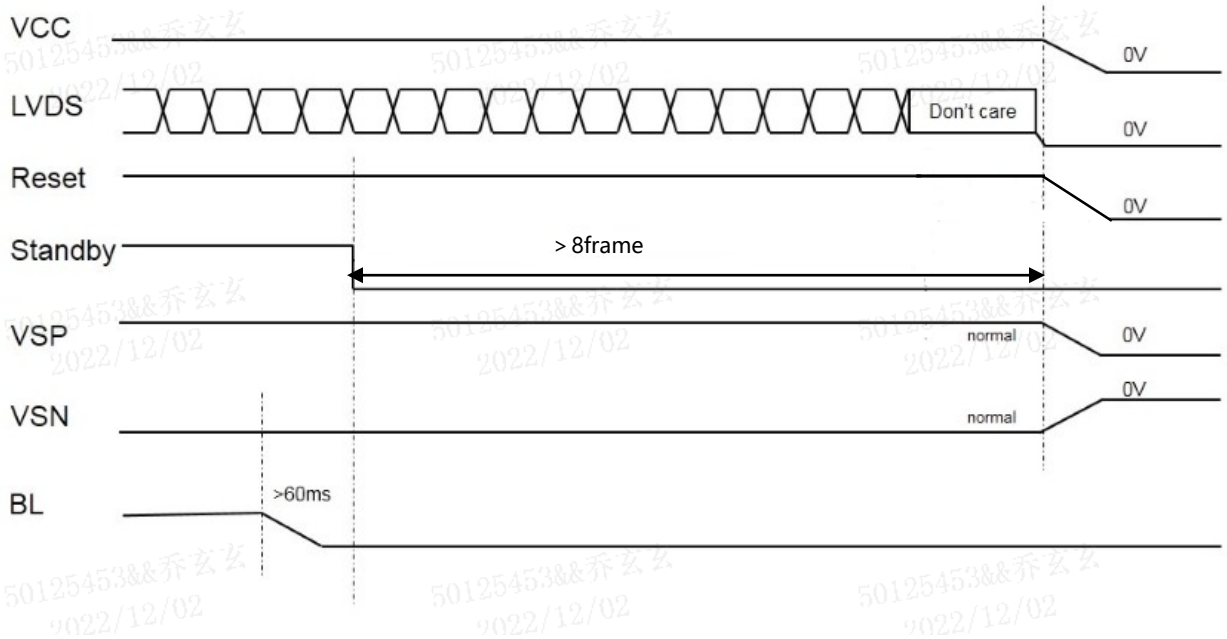

Note: Reset 可与 VDD 下电同步

SPEC. NUMBER
TBD

SPEC TITLE

PAGE
22 OF 21